



Depuis plus de 35 ans à votre service...

GRANDCASA



ABRIS DE JARDIN • POOLHOUSES • BUREAUX DE JARDIN
TONNELLES • GARAGES • CARPORTS • STUDIOS • CHALETS

CATALOGUE 2025

DU SUR-MESURE
AVEC AU CHOIX LES OPTIONS DE CE CATALOGUE
AU PRIX STANDARD

MaisonBoisChalet.com

Toutes les annexes sont livrées à la couleur d'origine (non colorées), sauf celles livrées avec l'option : autoclave vert.



Promouvoir
la gestion
durable
de la forêt
www.pefc.org

CONTENU



Durabilité	6 - 7
Classic	8 - 21
Cosmos	22 - 33
Mimas	34 - 41
Cottage & Country	42 - 57
Granges	58 - 63
Fenêtres & portes	64 - 67
Royal	68 - 77
PEFC	78 - 79
Style Monopente	80 - 87
Chalets forestiers	88 - 95
Industry	96 - 104
Couverture du toit	105
Abris de salon	106 - 113
Wellness sauna	114 - 119
She Shed	120 - 125
Style rural	126 - 131
Teintes et entretien	132 - 133
Elegance	134 - 147
Bureaux de jardin	148 - 153
Intérieur	154 - 155
Chalets de loisirs	156 - 165
Isolation	166
Garages	168 - 177
Tonnelles	178 - 186
Options	187
Teintes et entretien : informations importantes	188 - 189
CONTACT	190

LÉGENDE



Épaisseur



Hauteur de faîte



Hauteur à côté

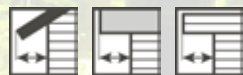

Débords de toit



Couvertures de toit



Pente du toit

TYPES DE TOITURE



Classic
toit en bâtière 19°



Toiture simple pente



Cottage
toit en bâtière 42°



Royal
toit pyramidal



Country
toit en croupe



Colorado
toit mansardé



Cosmos
toit plat



Toit asymétrique

POUR LA GESTION DURABLE DES FORÊTS





UN TRAVAIL SUR MESURE EN 3 ÉTAPES

2



UN TRAVAIL SUR MESURE EN 3 ÉTAPES

1

VOTRE IDÉE

Tout commence avec votre idée de la construction de vos rêves. Notre catalogue peut vous aider à trouver l'inspiration. Vous pouvez faire quelques dessins et/ou croquis.



2

CONTACTEZ -NOUS

Au [06.08.30.91.59](tel:06.08.30.91.59) en nous laissant un message si répondeur ou par email à maisonboischalet@aol.fr ou en nous rencontrant à [notre exposition](#). (voir adresse et horaires sur la dernière page).



3

VOTRE DEVIS PERSONNALISÉ

Nous traduirons vos souhaits de façon technique et évaluerons la faisabilité de votre projet.

Sur la base de cet entretien, nous vous remettons un devis personnalisé du projet de vos rêves.

DU SUR-MESURE À DES PRIX STANDARDS

- ✓ UN CERTIFICAT D'AUTHENTICITÉ
- ✓ AUCUN PRODUIT NE VIENT D'EUROPE DE L'EST, C'EST GARANTI !!
- ✓ UN INTERLOCUTEUR DIRECT QUE VOUS POUVEZ RENCONTRER.



PRODUITS DE CHEZ NOUS

CERTIFICAT D'AUTHENTICITÉ = CERTIFICAT D'ORIGINE

Un certificat d'authenticité est en réalité un certificat d'origine.

De cette manière, nous vous garantissons que votre chalet Grandcasa est un produit d'origine qui provient de nos manufactures et a été produit dans les pays du Benelux selon le principe des profilés de chalet coupe-vent, notre label de qualité Force Plus.

Ce label de qualité garantit également l'origine et la qualité du bois.

Les chalets de la marque Grandcasa sont aussi certifiés PEFC.

Le certificat d'origine de nos chalets vous garantit que votre chalet a été produit en suivant un processus de production de qualité conforme aux normes occidentales avec du bois de qualité, cultivé dans le respect de l'environnement. Nous avons développé ce certificat d'authenticité parce qu'il existe sur le marché des produits bien meilleur marché, mais de qualité moindre, fabriqués en Europe centrale et/ou de l'Est selon un processus de fabrication douteuse et avec du bois de moins bonne qualité. Souvent, la vraie qualité du produit est passée sous silence, mais le client apprend tôt ou tard les conséquences désastreuses de son choix. Nous vous conseillons donc d'acheter un chalet avec un certificat d'origine. Au final, vous ferez des économies. Méfiez-vous des copies bon marché provenant d'Europe de l'Est.

DEMANDEZ TOUJOURS VOTRE CERTIFICAT D'AUTHENTICITÉ!

Faites attention aux
constructions inférieures
qui proviennent
de l'Europe de l'Est.

SERVICE ET GARANTIE

Notre service après-vente français est disponible
5 jours sur 7, du matin au soir.

Nos services de production et service après-vente
réservés à nos professionnels se situent en Belgique,
à proximité de nos clients.



CERTIFICAT D'AUTHENTICITE



PRODUIT DE CHEZ NOUS

GRANDCASA
LE SPÉCIALISTE DU SUR MESURE

Par ce certificat on déclare que la construction Grandcasa, objet du bon de commande....., est une production authentique originaire du site de production à Elversele, Belgique, et également produit selon la norme de qualité Force Plus pour les profils en coupe-vent.

Ce certificat garantit également que la construction mentionnée ci-dessus est construite avec du bois qualitatif-pin, originaire du Nord de l'Europe, livrée conforme à la norme NEN(5466) avec le certificat KOMO correspondant et certifiée PEFC (CoC N° CTIB-TCHN 0938).

Elversele - Belgique, 2025

Emis par:
Pontweg 9C - 9140 Elversele - Belgique



PROFIL IMPERMÉABLE AU VENT

- Double fraisage
- Les plus grandes rainures et languettes du marché. 15 mm assure une plus grandes robustesse



DU BOIS DE QUALITÉ

Les chalets Grandcasa sont fabriqués avec du pin de qualité provenant d'Europe du Nord, selon les normes NEN 5466, et ils sont livrés avec un certificat KOMO. Le froid fait pousser ces arbres plus lentement, ce qui rend le bois plus solide et permet de garantir une durée de vie sensiblement plus longue à nos chalets.

LA BOUCLE DE DURABILITÉ



À travers La marque **Grandcasa**,
MaisonBoisChalet / ASR
souhaite explicitement contribuer au
développement durable.

Notre concept se fonde sur la définition formulée
par les Nations Unies en 1987 :

*" Le développement durable est
un développement qui répond
aux besoins du présent sans
compromettre la capacité des
générations futures de répondre
à leurs propres besoins. "*

Par conséquent, nous mettrons tout en
œuvre pour contribuer à la préservation de
notre planète grâce à la production aussi
respectueuse que possible de l'environnement
et aux applications qui respectent une
vision écologique de la vie et peuvent être
fondamentalement considérées comme
durables.



Voilà pourquoi 'nos chalets boucle de durabilité' se fonde sur 3 facettes.

**1**

Les panneaux solaires installés sur le toit de nos usines couvrent 45 % des besoins en électricité pour notre production. La production annuelle attendue est supérieure à 211 000 kWh, fournie par 576 modules à haut rendement en cristallin.

De plus, notre bois traité est entièrement certifié PEFC (voir plus loin).

**2**

Nos constructions de jardin en bois sont dotées de structures de toit très solides qui peuvent parfaitement servir de base à l'aménagement d'un toit vert **extensif** (épaisseur \geq 45 mm obligatoire)

**3**

Nos structures de toit, y compris nos toits plats, sont suffisamment solides et conviennent même parfaitement à l'installation de panneaux.

Nos constructions de jardin jouent ainsi un rôle important dans la production privée d'énergie renouvelable.

CLASSIC





CLASSIC

Notre gamme Classic propose des abris de jardin de caractère et d'excellente qualité avec en plus un look distinctif et authentique.

Nos modèles Classic taillés sur mesure vous donneront aussi une série des idées bien pensées pour réaliser vos rêves en matière d'abris de jardin.

AVANTAGES

- Pente de toit de 19°
- Portes surélevées (196 cm)
- Vaste assortiment de fenêtres et portes avec toujours du verre authentique
- Le plus grand choix de toitures : shingles, panneaux profilés métalliques, panneaux de tuiles
- Possibilité abri annexe



CLASSIC BASIC



Façade:	1 - 10 m
Profondeur:	1 - 30 m
Hauteur:	2,77 - 3,80 m
Fenêtres:	
Portes:	



CLASSIC BASIC

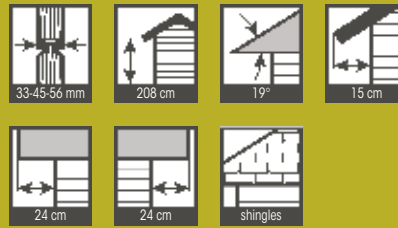

Avec bûcher



Avec auvent



Configurations possibles



CLASSIC

JUDA

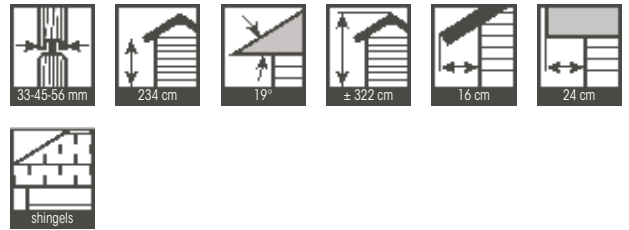
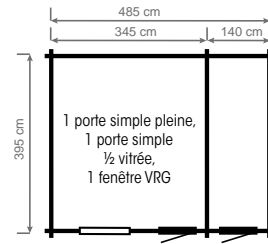

PADRO

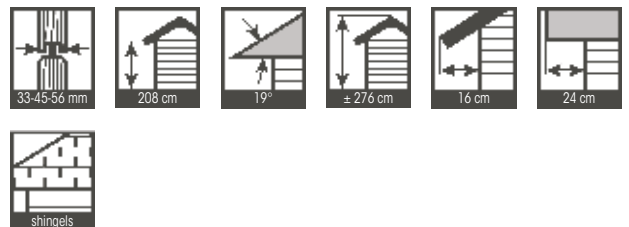
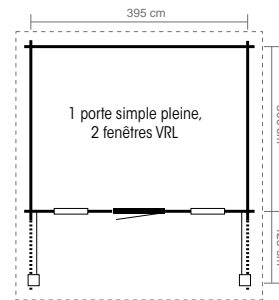

CHALKI

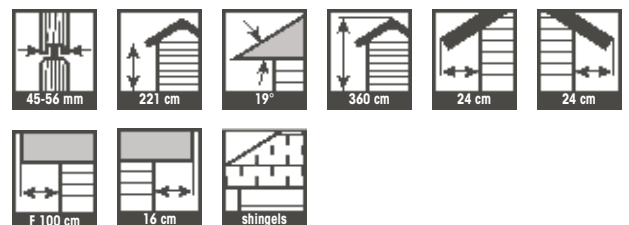
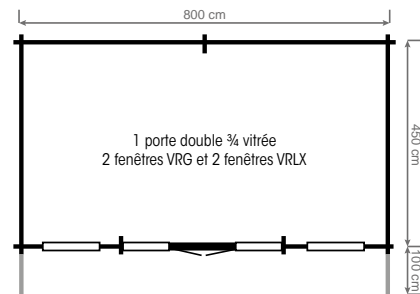



BARBADOS

dakpanplaten optioneel

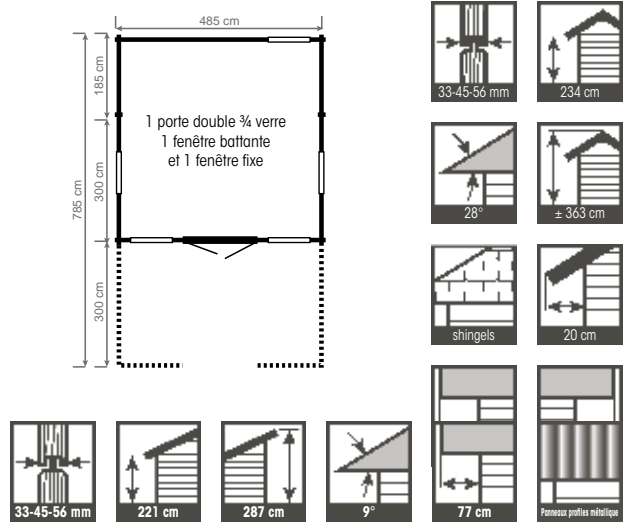

COLORADO

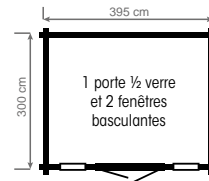

Disponible en différentes dimensions

PETRUS

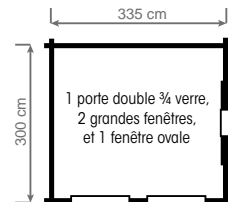

CLASSIC

DAVOS

panneaux de tuile et set gouttières en option

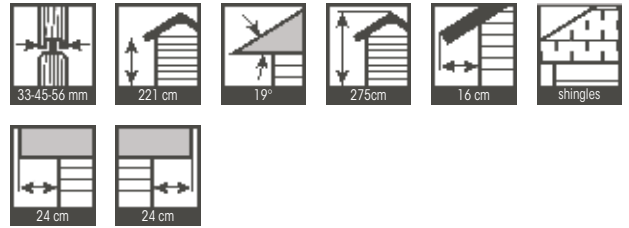
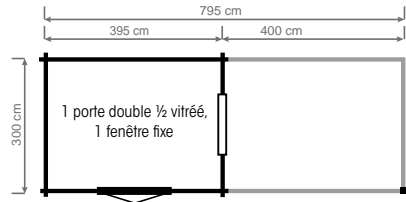

BELIZE

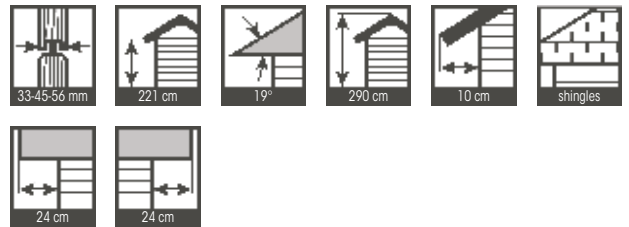
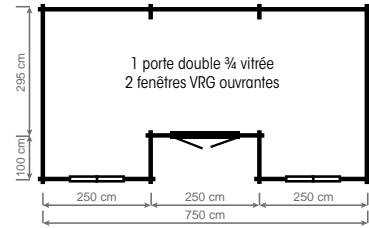

CARTAGENA

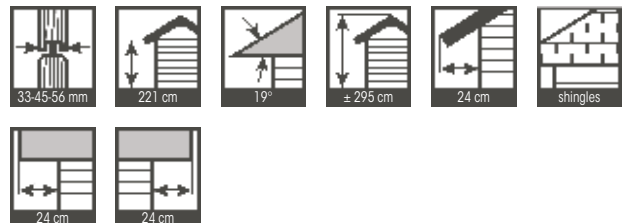
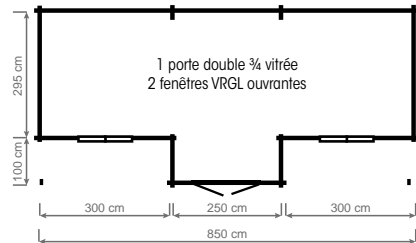



KRETA



set de gouttières en option

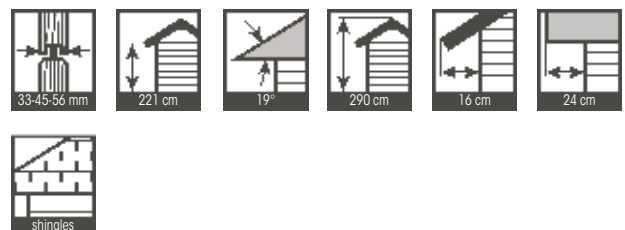
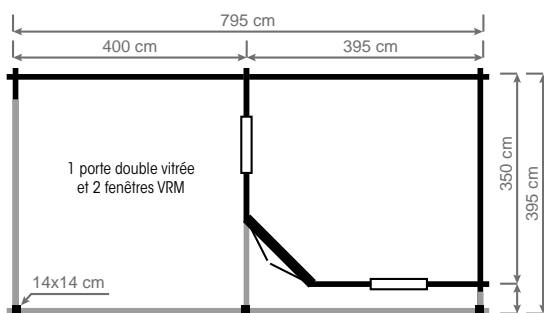

CLASSIC

MAKIRA

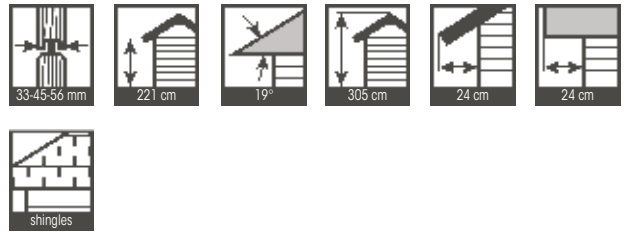
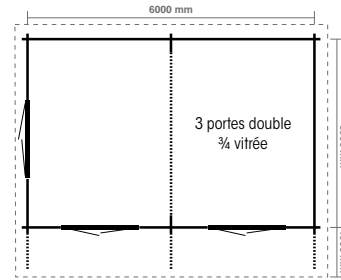

BONAIRE

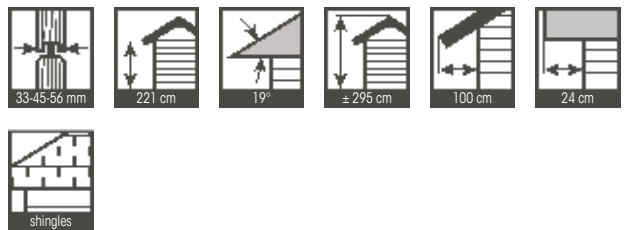
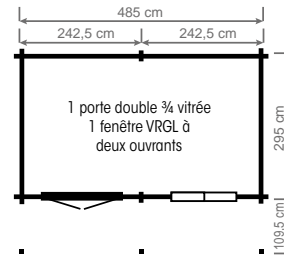

ROATAN

set de gouttières et panneaux tuiles en option

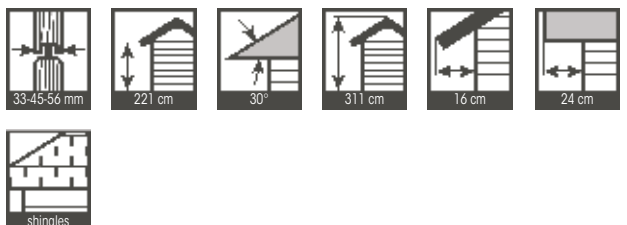
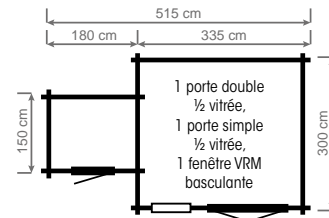



EVORA

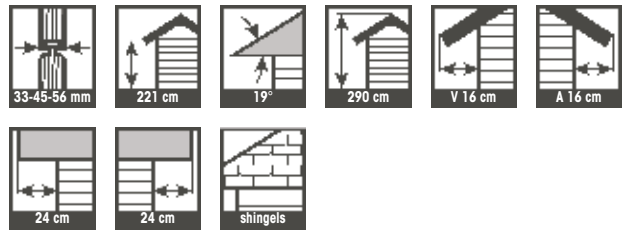
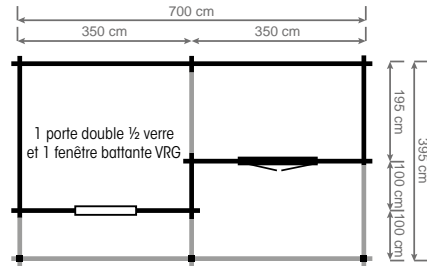

KAMANA

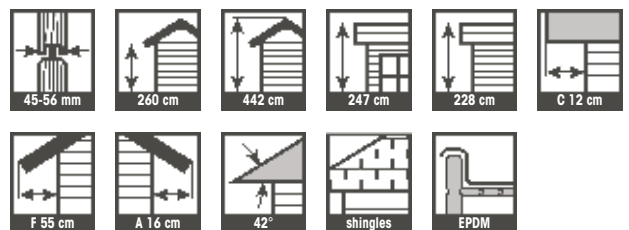
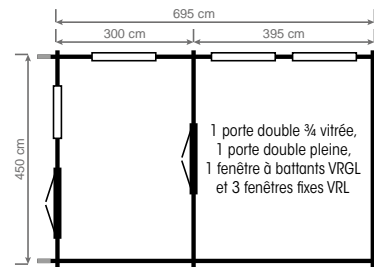

BENIA

panneaux de tuile en option

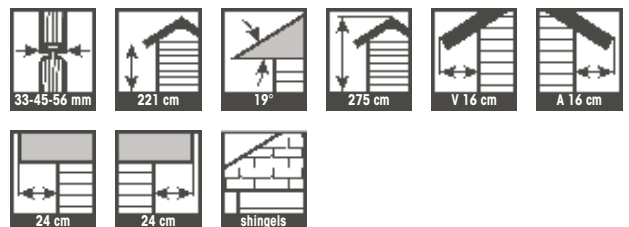
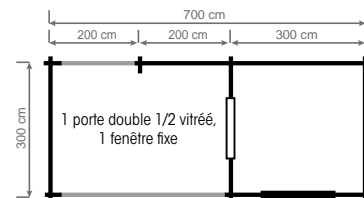

CLASSIC

RODOS

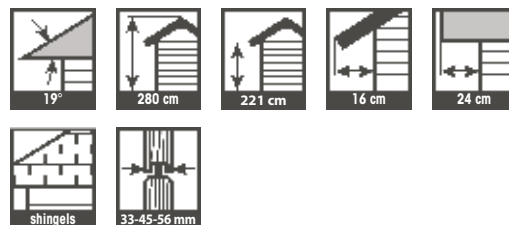
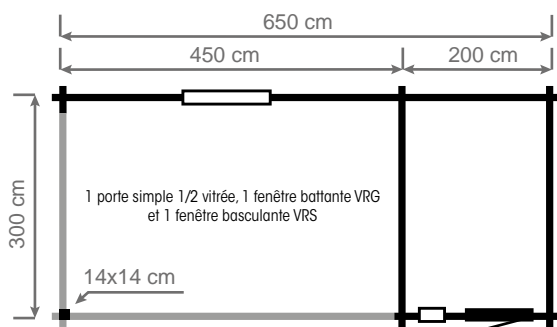



KALYMOS

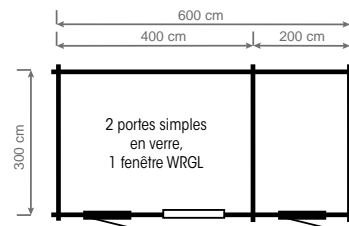

TINOS

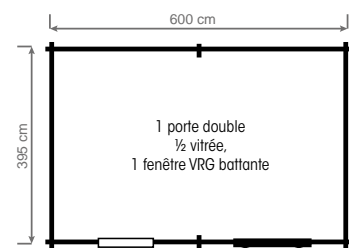

SAMOS

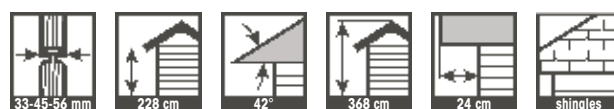
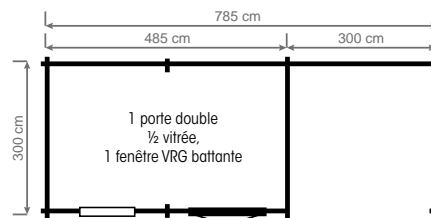

CLASSIC



BARANQUILA

set de gouttières en option

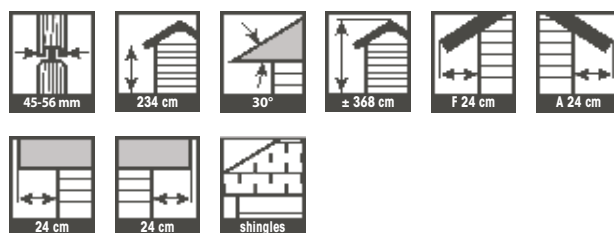
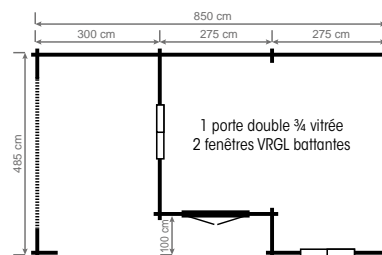

ANDROS

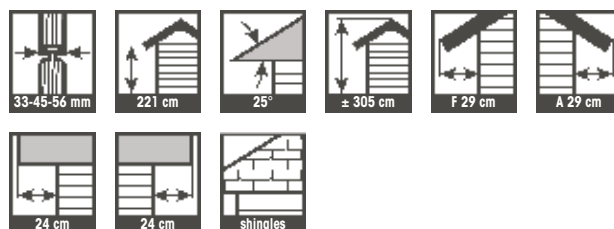
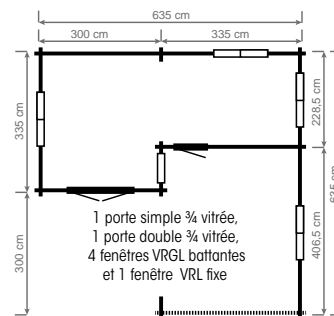

PAROS

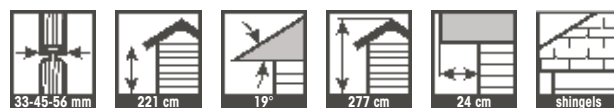
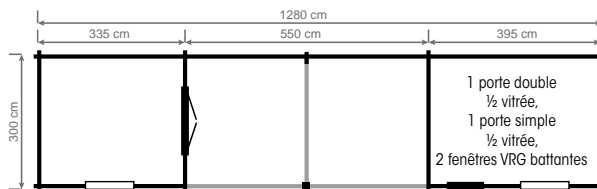



PRODUITS DE CHEZ NOUS



CERTIFICAT D'AUTHENTICITE



Par ce certificat on déclare que la construction Grandcasa, objet du bon de commande _____, est une production authentique originaire du site de production à Elversele, Belgique, et également produit selon la norme de qualité Force Plus pour les profils en coupe-vent.

Ce certificat garantit également que la construction mentionnée ci-dessus est construite avec du bois qualitatif-pin, originaire du Nord de l'Europe, livrée conforme à la norme NEN(5466) avec le certificat KOMO correspondant et certifiée PEFC (CoC N° CTIB-TCHN 0938).

Elversele - Belgique, 2025



Emis par:
Pontweg 9C - 9140 Elversele - Belgique



CERTIFICAT D'AUTHENTICITÉ = CERTIFICAT D'ORIGINE

Un certificat d'authenticité est en réalité un certificat d'origine. De cette manière, nous vous garantissons que votre chalet Grandcasa est un produit d'origine qui provient de nos manufactures et a été produit dans les pays du Benelux selon le principe des profilés de chalet coupe-vent, notre label de qualité Force Plus.

Ce label de qualité garantit également l'origine et la qualité du bois. Les chalets de la marque Grandcasa sont aussi certifiés PEFC.

Le certificat d'origine de nos chalets vous garantit que votre chalet a été produit en suivant un processus de production de qualité conforme aux normes occidentales avec du bois de qualité, cultivé dans le respect de l'environnement. Nous avons développé ce certificat d'authenticité parce qu'il existe sur le marché des produits bien meilleur marché, mais de qualité moindre, fabriqués en Europe centrale et/ou de l'Est selon un processus de fabrication douteuse et avec du bois de moins bonne qualité. Souvent, la vraie qualité du produit est passée sous silence, mais le client apprend tôt ou tard les conséquences désastreuses de son choix. Nous vous conseillons donc d'acheter un chalet avec un certificat d'origine. Au final, vous ferez des économies. Méfiez-vous des copies bon marché provenant d'Europe de l'Est.

DEMANDEZ TOUJOURS VOTRE CERTIFICAT D'AUTHENTICITÉ!

Faites attention aux constructions inférieures de l'Europe de l'Est

SERVICE ET GARANTIE

Notre service après-vente français est disponible 5 jours sur 7, du matin au soir. Nos services de production et service après-vente réservés à nos professionnels se situent en Belgique, à proximité de nos clients.

PROFIL IMPERMÉABLE AU VENT DU BOIS DE QUALITÉ

- Double fraisage
- Les plus grandes rainures et languettes du marché. 15 mm assure une plus grande robustesse



Les chalets Grandcasa sont fabriqués avec du pin de qualité provenant d'Europe du Nord, selon les normes NEN 5466, et ils sont livrés avec un certificat KOMO. Le froid fait pousser ces arbres plus lentement, ce qui rend le bois plus solide et permet de garantir une durée de vie bien plus longue à nos chalets.

COSMOS





COSMOS

Cette gamme est synonyme de design moderne, sobre et contemporain. Le toit plat est équipé d'un système d'écoulement. L'eau est ainsi évacuée par l'arrière avec un ensemble de gouttières compris dans l'offre standard. Ces constructions sont assorties de portes pleines standard ou des portes en verre dépoli.

EPDM AVEC AVALOIR POUR ÉGOUTTAGE



AVANTAGES

- Sous-toiture : planches massives de 19 mm, dent/rainure
- Gouttière avec système d'écoulement compris
- Toiture : caoutchouc EPDM, 400% élastique, finition avec un profilé en aluminium élégant de 35 x 45 mm avec angles prémontés
- Plaques métalliques galvanisées en option
- Gamme de portes et fenêtres contemporaines, pleines ou en verre authentique, brillantes ou mates



COSMOS BASIC



Façade:	1 - 30 m
Profondeur:	1 - 10 m
Hauteur:	2,47 m
Fenêtres:	
Portes:	



COSMOS BASIC

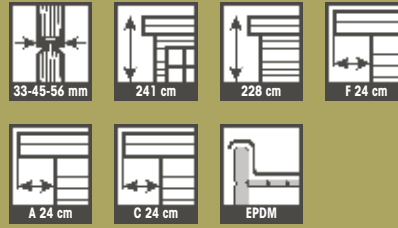

Avec bûcher



Avec auvent



Configurations possibles

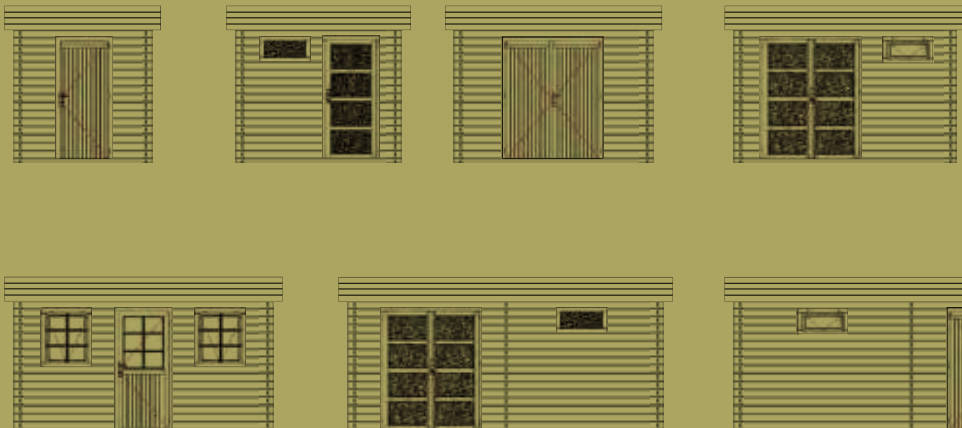

COSMOS

LESBOS

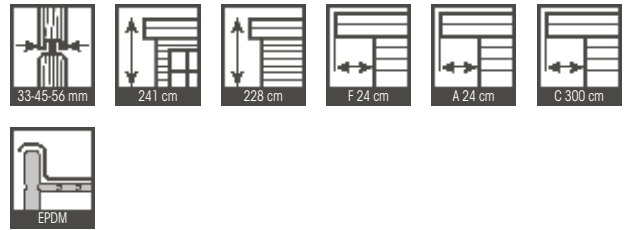
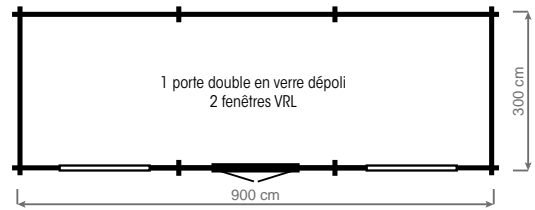

PINTA

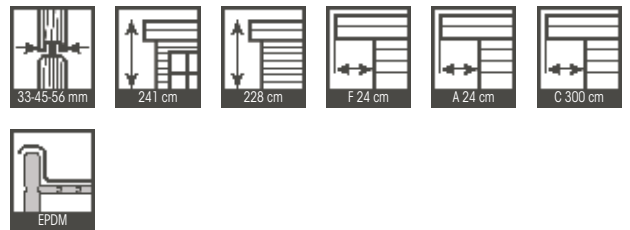
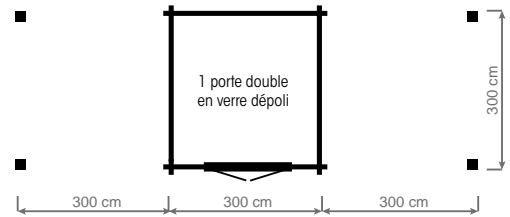

NASSAU

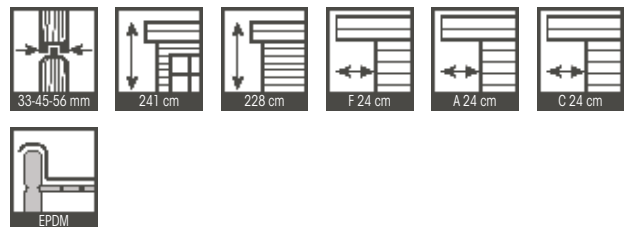
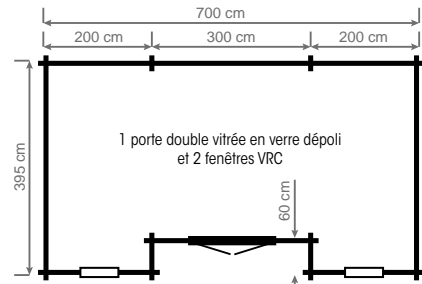



MARTINA

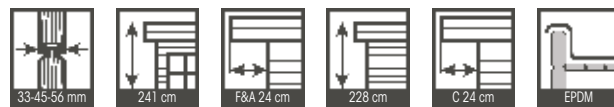
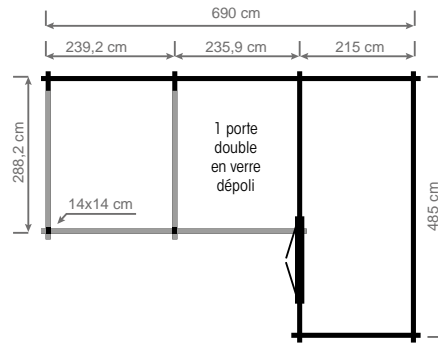

AGNETA

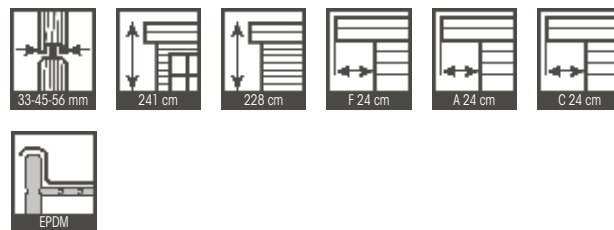
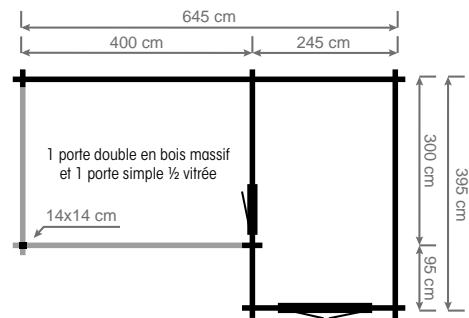

DIONE

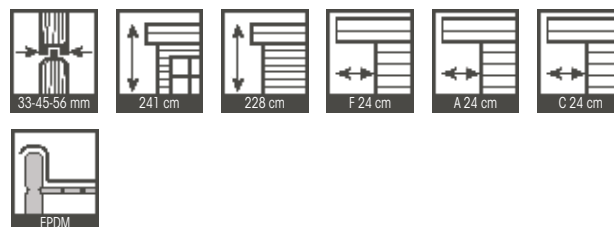
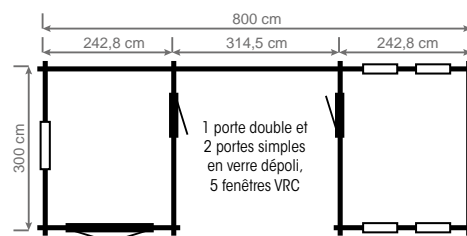

COSMOS

HAFA

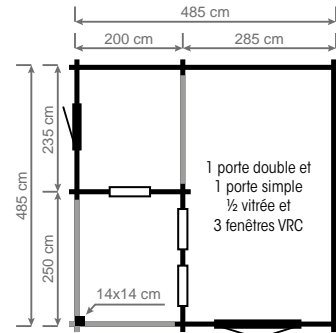

GUYANA

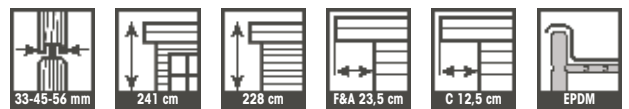
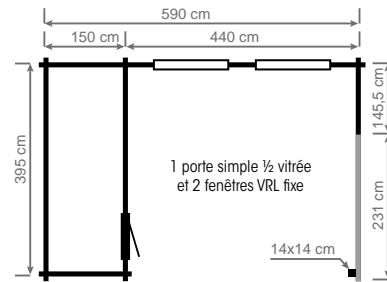

TATIANA

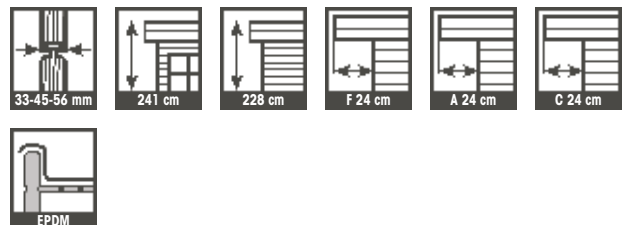
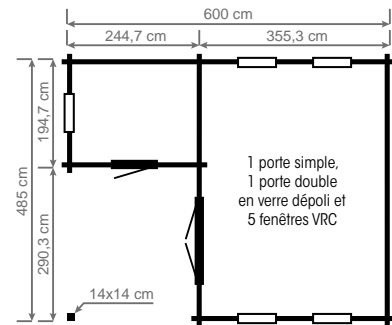



CÉZANNE

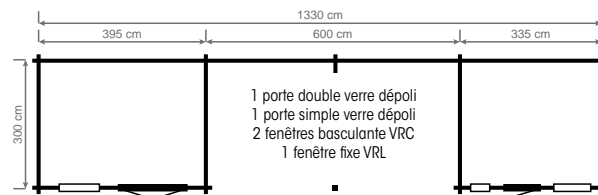

FABRE

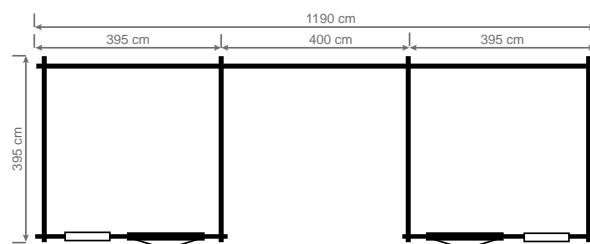

2 portes doubles verre dépoli, 2 fenêtres basculantes

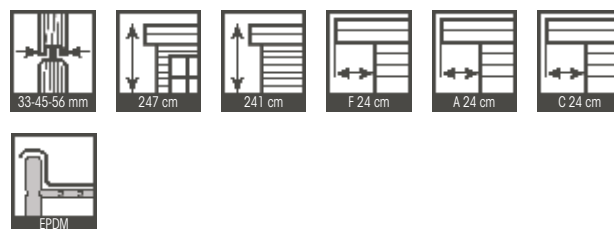

MATTIS

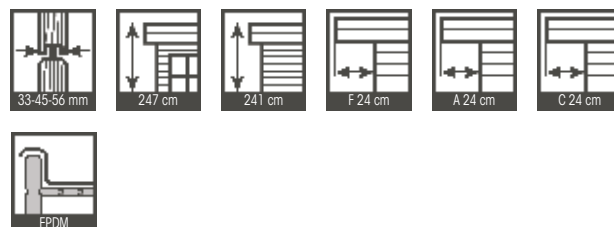
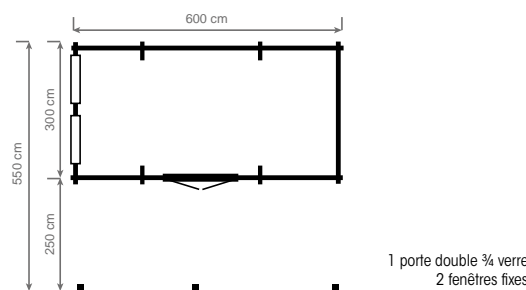

COSMOS

MARGARITA

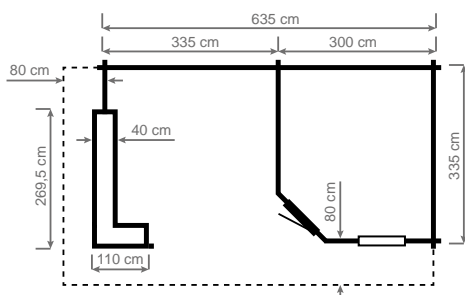

1 porte simple d'angle en verre dépoli, 1 fenêtre VRL fixe avec verre dépoli

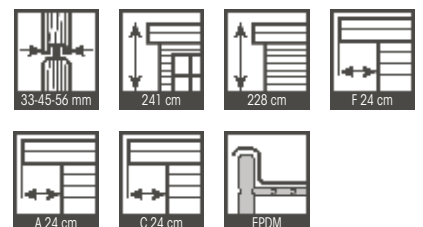



KONYA

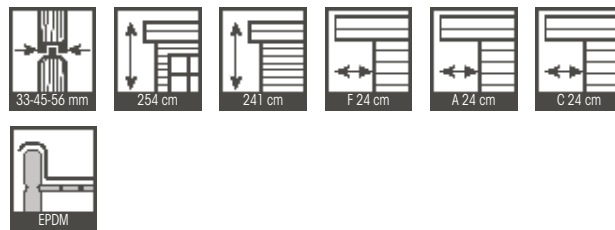
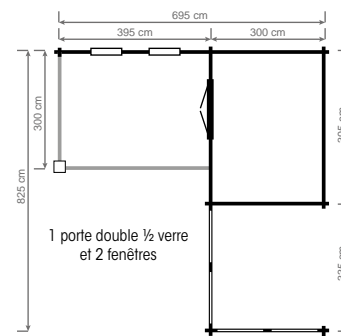

SAMSUN

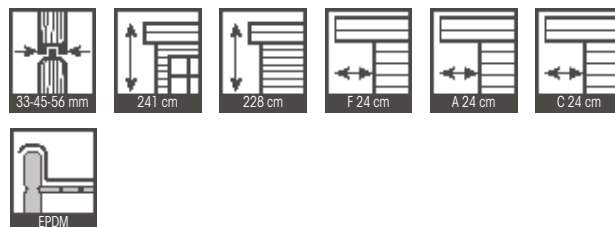
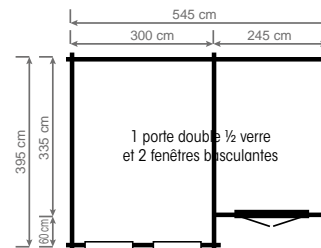

DENZILI

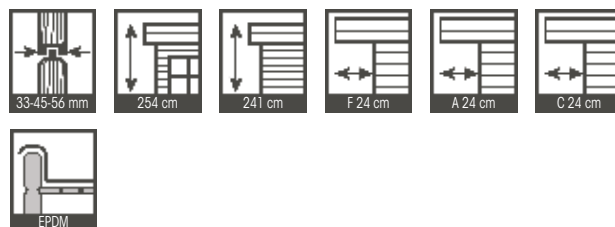
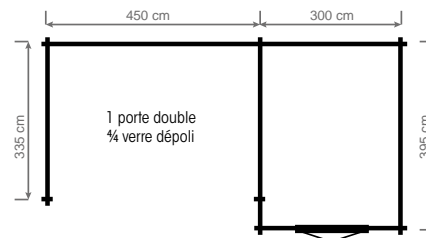

COSMOS

MALIFARU

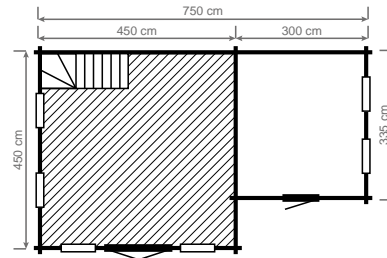

1 double et 1 simple ¼ porte verre dépoli, 5 fenêtres fixes verre dépoli VRV et 2 fenêtres basculantes VRC

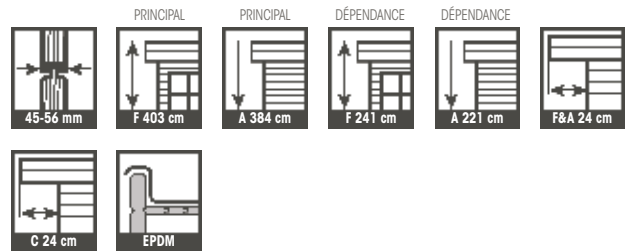

DUVARI

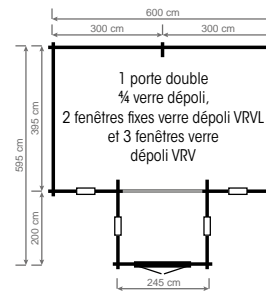

1 porte double ¼ verre dépoli, 2 fenêtres fixes verre dépoli VRVL et 3 fenêtres verre dépoli VRV

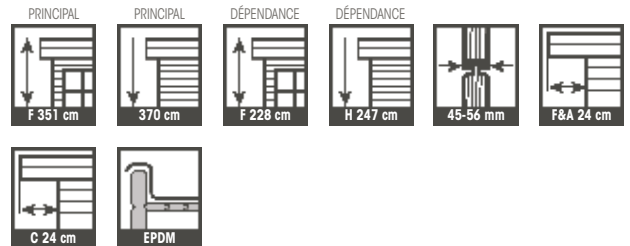

MELAMU

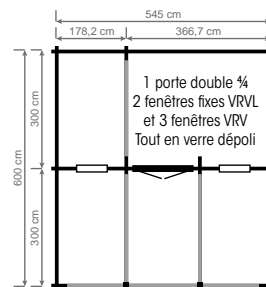

1 porte double ¼ et 2 fenêtres fixes VRVL et 3 fenêtres VRV Tout en verre dépoli

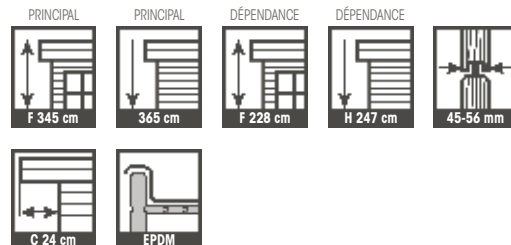



OSUMI

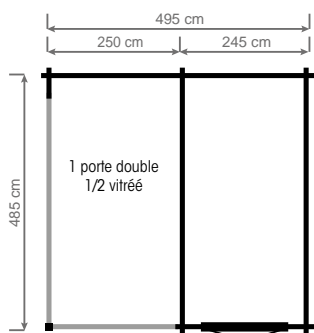

MIMAS





MIMAS

Le projet Mimas à été réalisé il y a quelques années. Une réponse à la croissance d'expérience de la vie en plein air.

Le jardin est de plus en plus un espace de vie supplémentaire.

AVANTAGES

- Sous-toiture : planches 19 mm avec languette/rainure
- Gouttières avec descente inclus
- Couverture du toit : EPDM, 400% élastique
- Gamme portes et fenêtres contemporaine, pleine ou vitrée (clair ou dépoli)
- Puit de lumière en verre de sécurité en polycarbonate trempé, haute résolution du bruit (-39 db)

OPTION: puit de lumière



MIMAS

MIMAS 1200

fenêtre dans le lounge en option

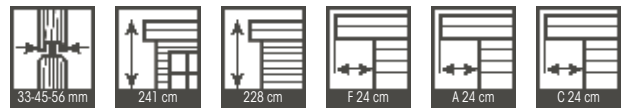
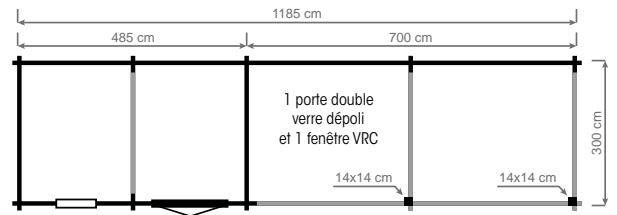

MIMAS PLUS

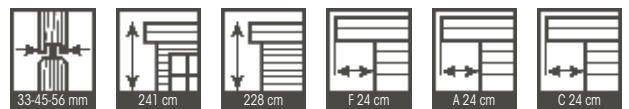
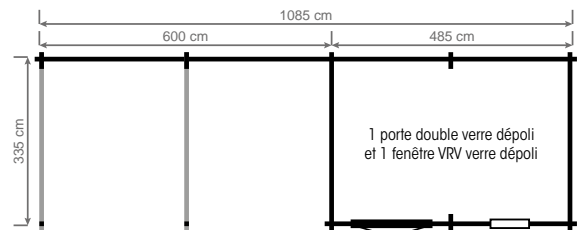

MIMAS CLASSIC

mur à coté en option

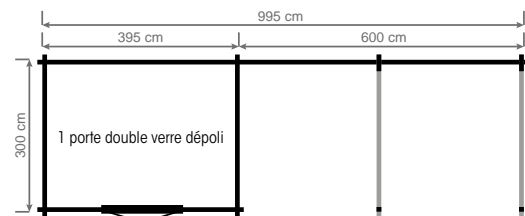



MIMAS 800

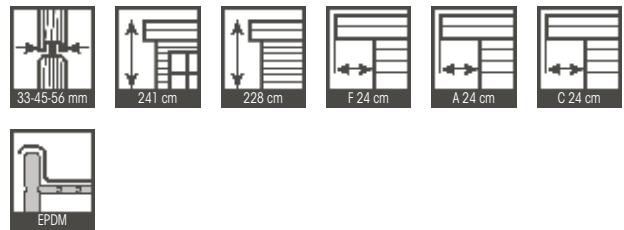
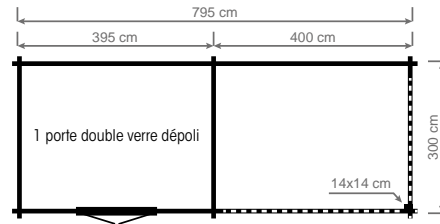

MIMAS 700

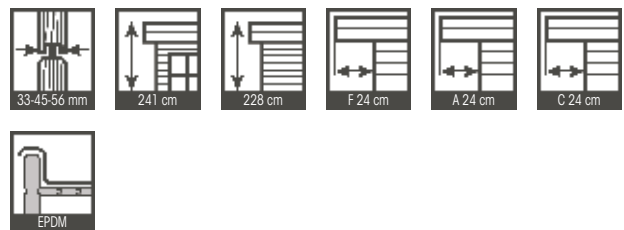
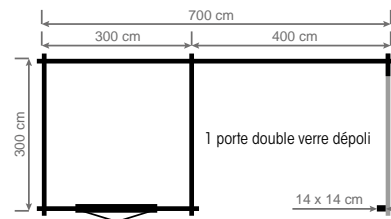

MIMAS 600

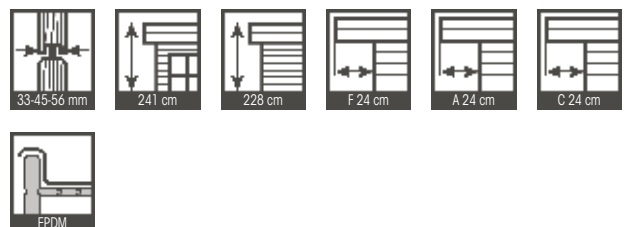
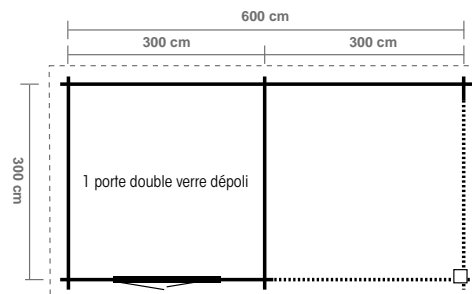

MIMAS

MIMAS 500

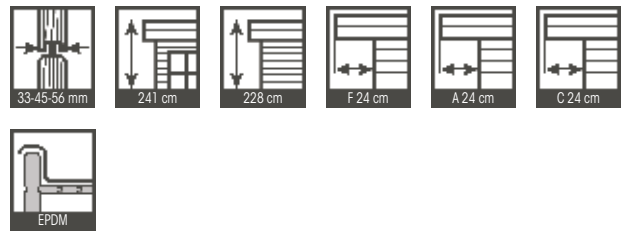
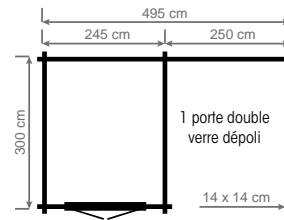

MIMAS PINAR

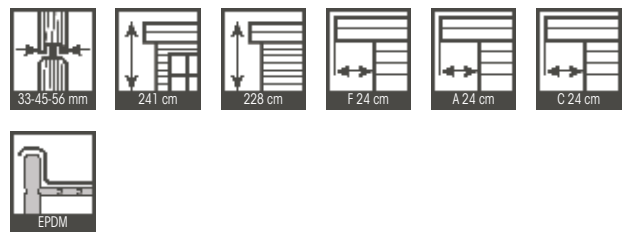
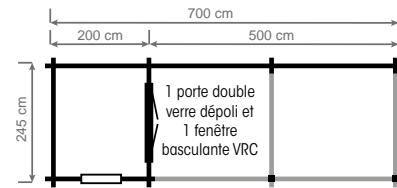

MIMAS EURA

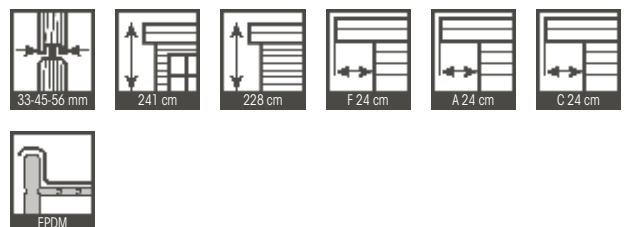
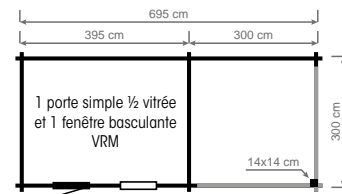



MIMAS GAUDI

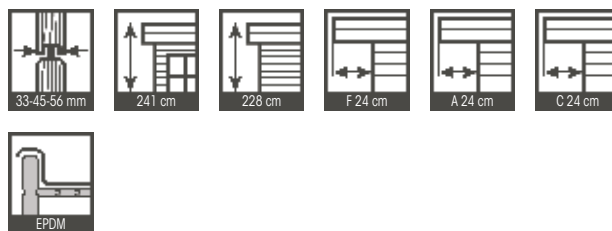
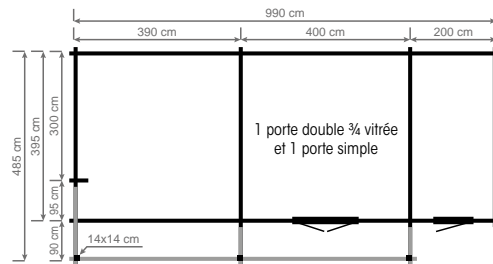

MIMAS GOYA

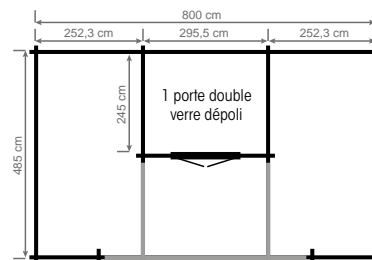

MIMAS ROCCA

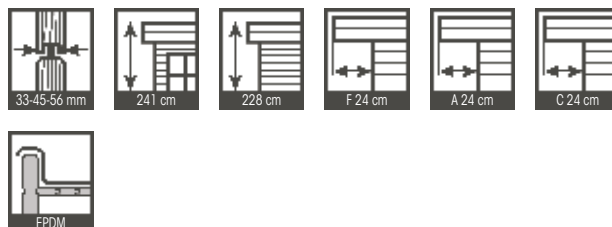
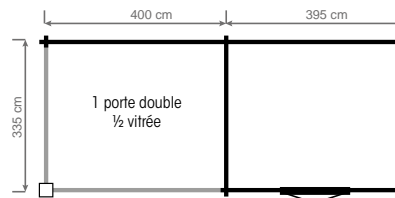

MIMAS

MIMAS MONET

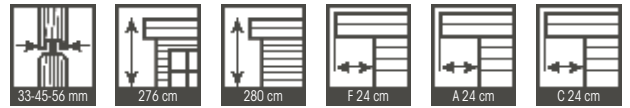
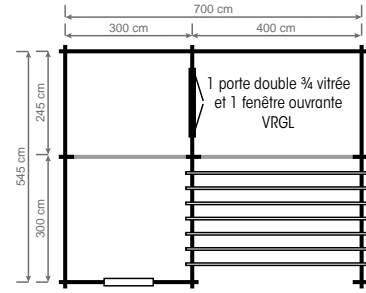

MIMAS ROYAL

avec un store vénitien

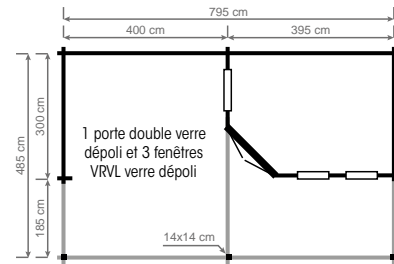

MIMAS DAHLI

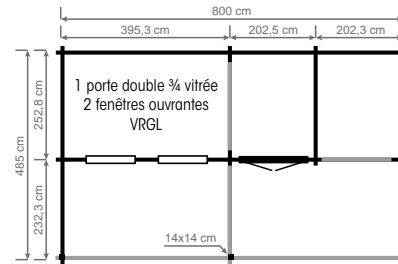



MIMAS GIGOT

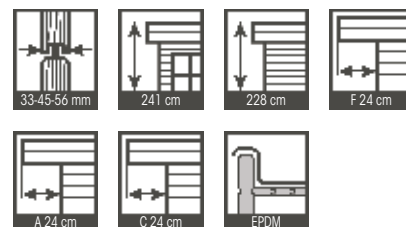
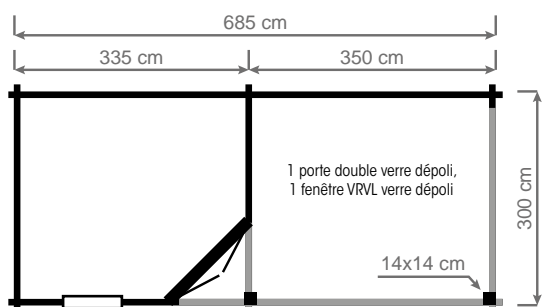

COTTAGE & COUNTRY





COTTAGE & COUNTRY

Nous avons développé plusieurs modèles pour vous dans le style des maisons anglaises, finition en bois de chêne optionnelle.

Notre système d'emboîtement nous permet de créer un alternatif, à bon prix, pour ses cabanes et maisons authentiques. Evidemment on vous propose une finition en bois de chêne, qui donnera à votre construction une valeur ajoutée avec beaucoup de présence.

Bien entendu, toutes les constructions sont livrables, si techniquement possible.

AVANTAGES

- Pente de toit de 42° avec toiture à 2 pans avec croupe
- Portes surélevées (196 cm) en exécution standard
- Vaste assortiment de fenêtres et portes avec, toujours, du verre authentique
- Nombreuses possibilités d'extension : standard shingles (4 types) et finition toiture de chaume exclusive
- Options: finition chêne pour les auvents et patio au moyen des poutres en chêne 14 x 14 cm et des supports



OPTION: finition chêne



COTTAGE & COUNTRY



Façade:	1 - 30 m
Profondeur:	1 - 6 m
Hauteur:	3,18 - 4,98 m
Fenêtres:	<p>VRK: 60 cm x 94 cm VRM: 82 cm x 94 cm VRI: 97,5 cm x 67,8 cm VRG: 119 cm x 94 cm VRS: 37,5 cm x 37,5 cm VRO: 50 cm x 63 cm</p>
Portes:	<p>VDE12: 92 cm x 196 cm VDE12A: 92 cm x 196 cm VDD12: 168 cm x 196 cm VDD13: 168 cm x 196 cm VDE00: 92 cm x 196 cm VDD00: 168 cm x 196 cm</p>



COTTAGE & COUNTRY BASIC



OPTION: poutres en chêne avec des étais assortis



Configurations possibles

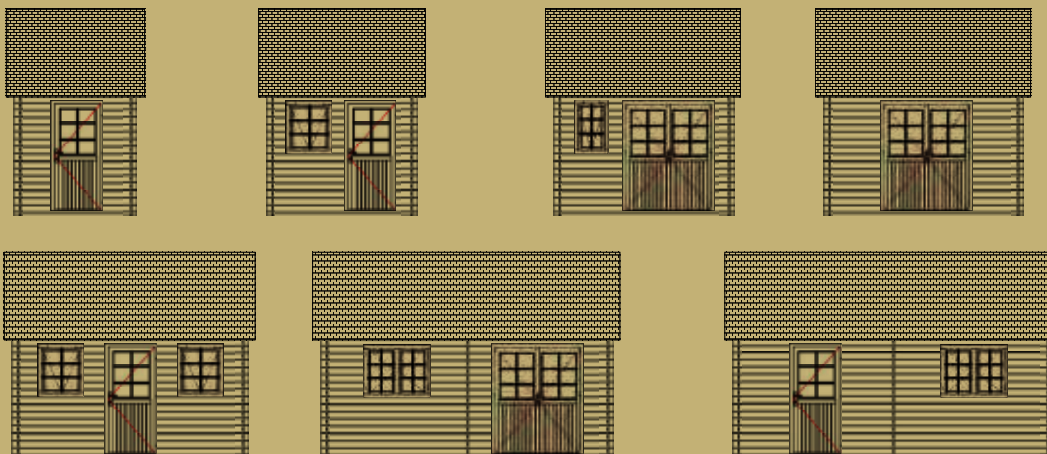

COTTAGE & COUNTRY

ORCHILA

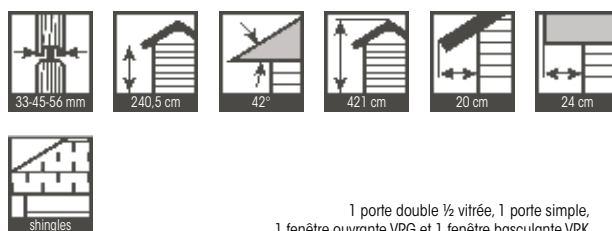
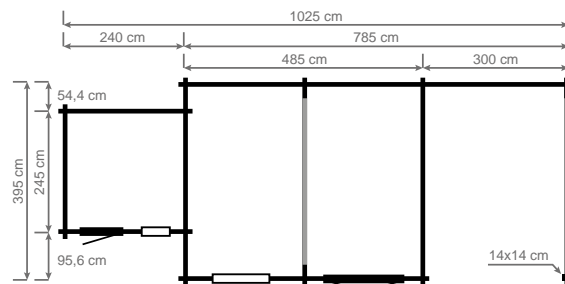

1 porte double ½ vitrée, 1 porte simple,
1 fenêtre ouvrante VRG et 1 fenêtre basculante VRK

MONTSERRAT

volets et set de gouttières zinc en option

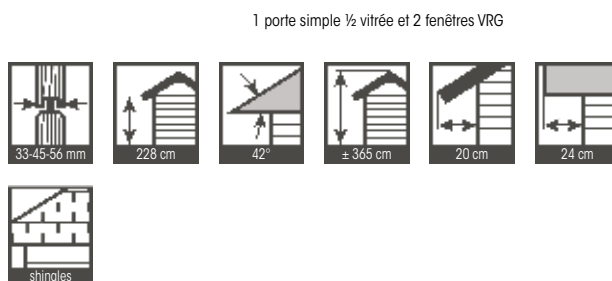
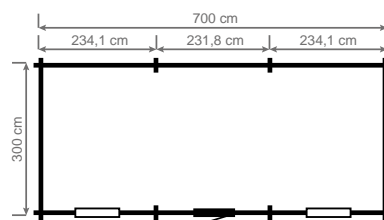

1 porte simple ½ vitrée et 2 fenêtres VRG

SANTA LUCIA

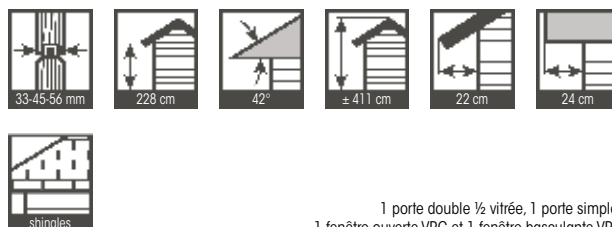
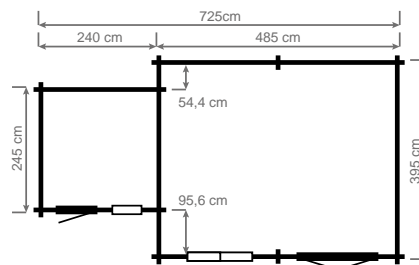

1 porte double ½ vitrée, 1 porte simple,
1 fenêtre ouverte VRG et 1 fenêtre basculante VRK



FLINT

piédestal en option

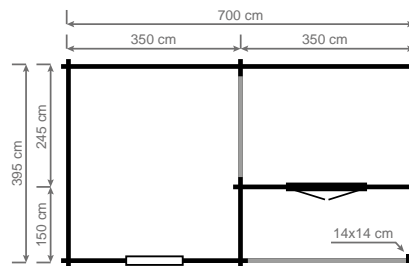

1 porte double 1/2 vitrée et 1 fenêtre basculante VRI

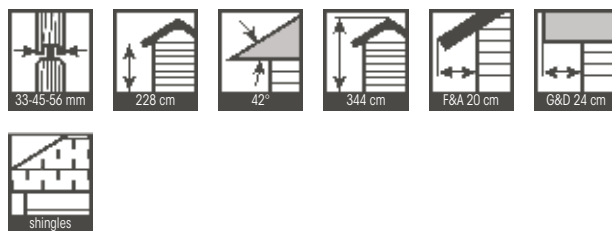

ARNOLD

panneaux de tuiles pas inclus

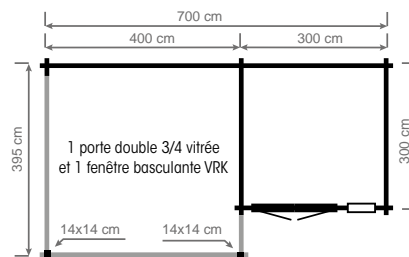

1 porte double 3/4 vitrée et 1 fenêtre basculante VRK

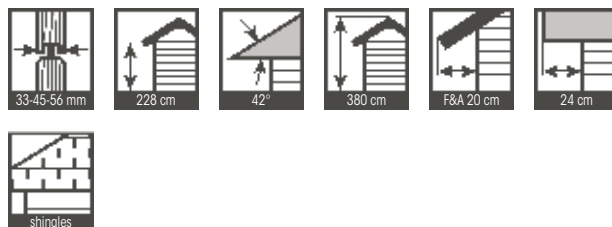

LANELLI

set de gouttières en option

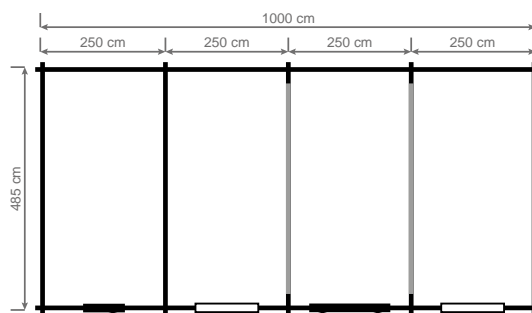

1 porte double et 1 porte simple vitrée et 2 fenêtres VRG

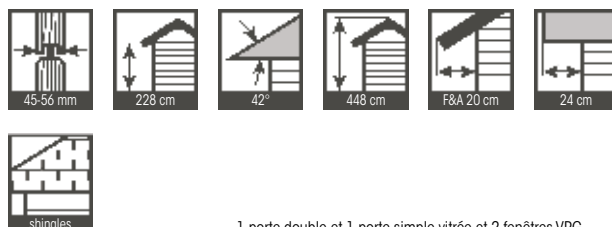

COTTAGE & COUNTRY

FINI

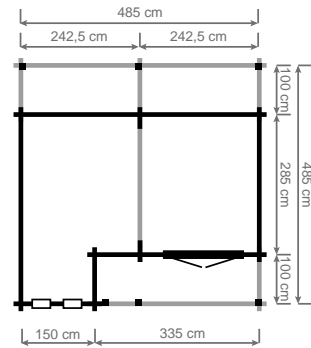

1 porte double pleine et 2 fenêtres basculantes VRS

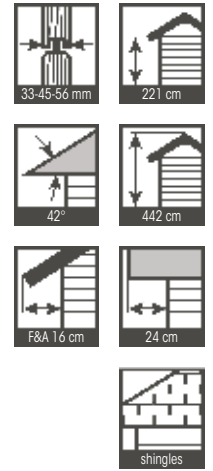

GRINTA

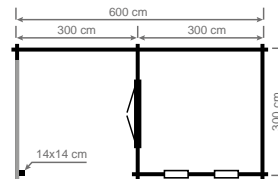

1 porte double 1/2 verre et 2 fenêtres basculantes VRK

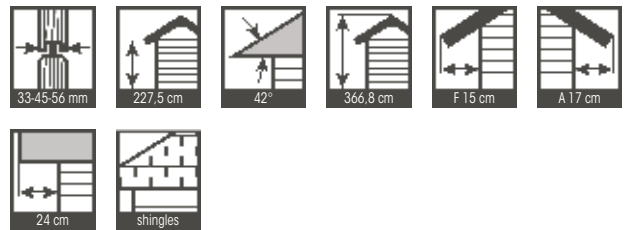

GOMERA

set de gouttières en option

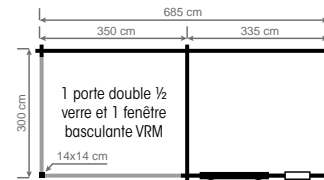



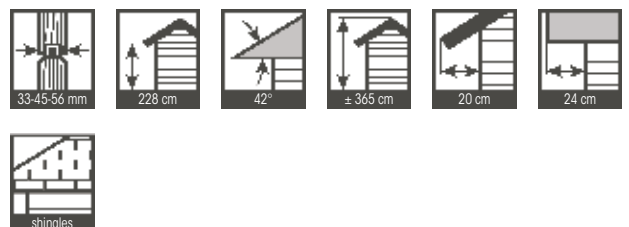





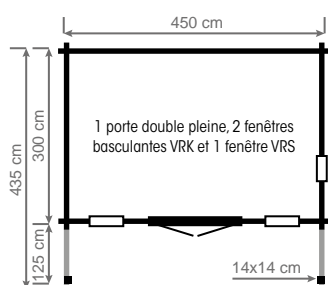

1 porte double 1/2 verre et 1 fenêtre basculante VRM





NELSON



 33-45-56 mm	 F 338 cm	 A 228 cm	 42°	 ± 420 cm	 F 125 cm
 A 20 cm	 C 24 cm	 shingles			

COTTAGE & COUNTRY

REDON

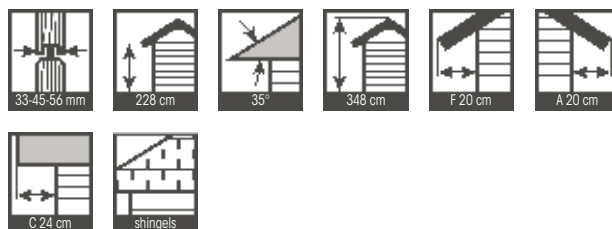
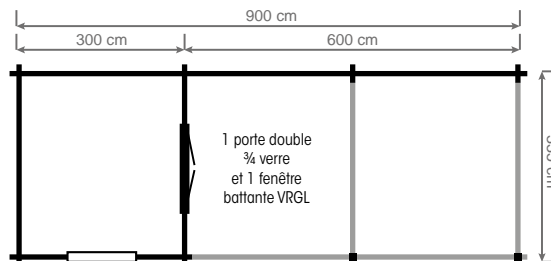

CASTEL

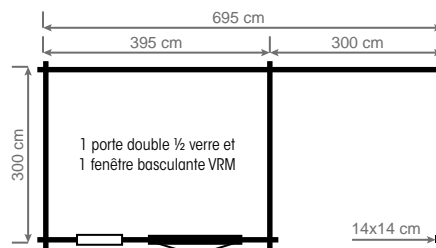

TORTEVAL

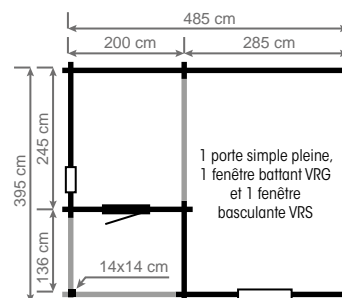



CONWY

Set de gouttières en option

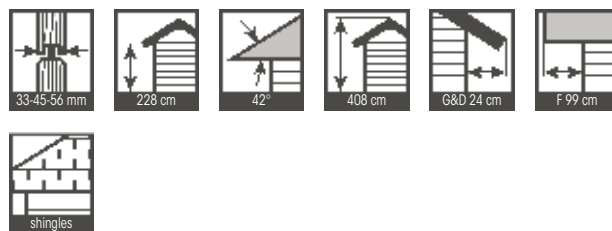
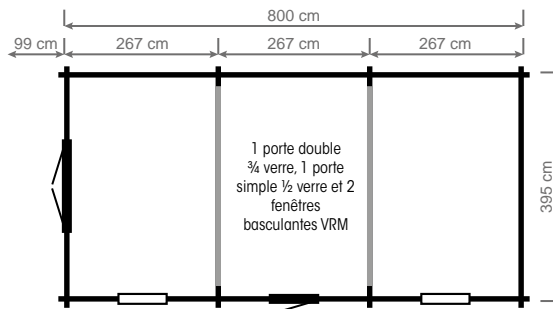

MANO

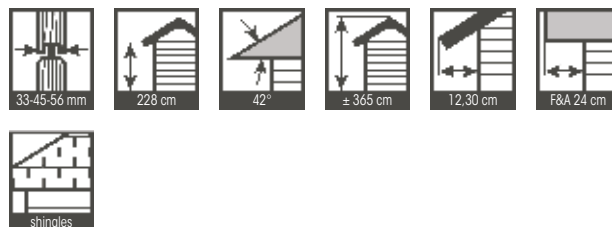
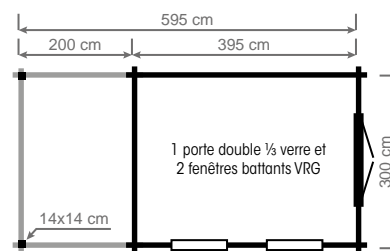

GLENAN

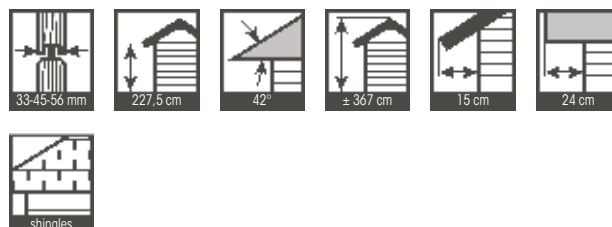
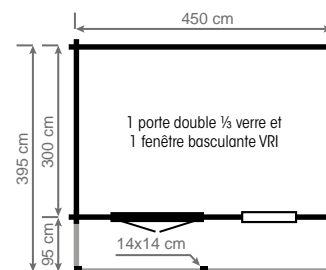

COTTAGE & COUNTRY

GAVRINIS

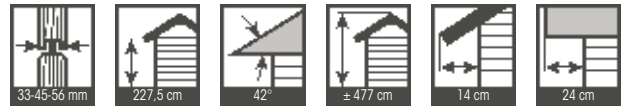
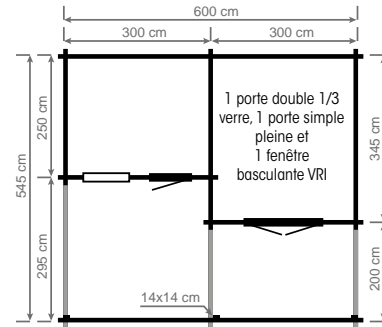

MALBAN

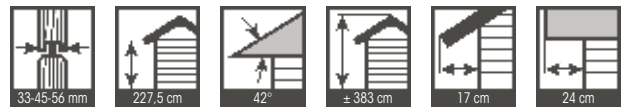
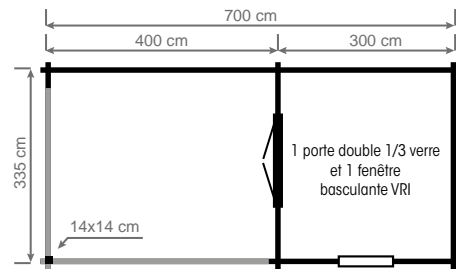

CASTILLE

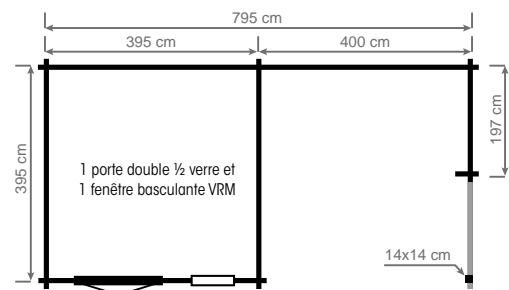



JERSEY

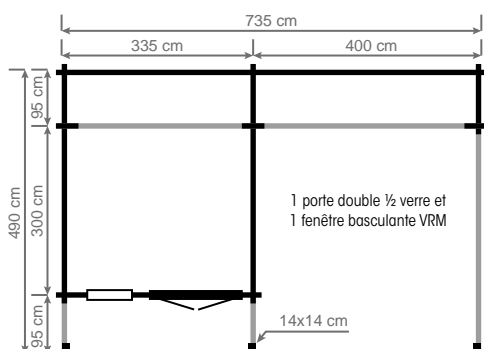

33-45-56 mm	F 221 cm	A 143 cm	42°	± 410 cm	F 130 cm
A 20 cm	C 24 cm	shingles			

COTTAGE & COUNTRY

QUEBERON

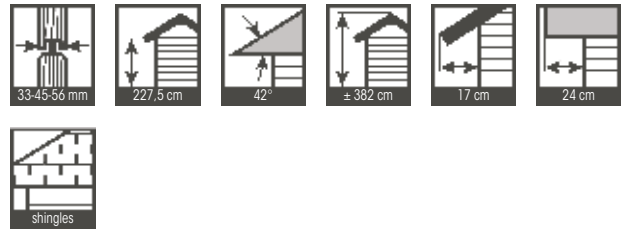
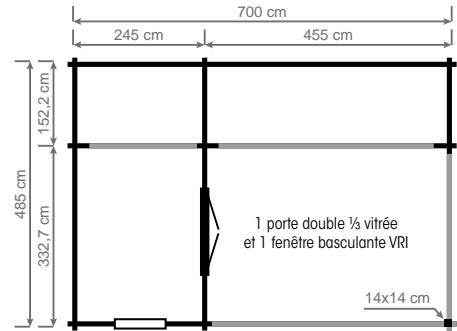

MICHEL

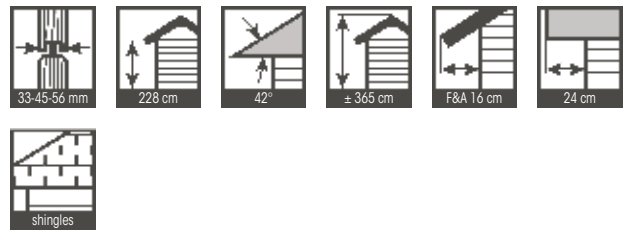
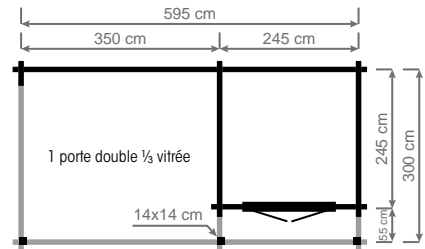

HERMES

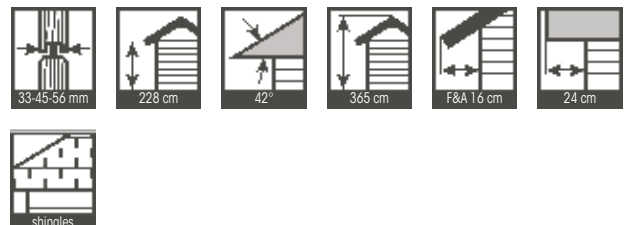
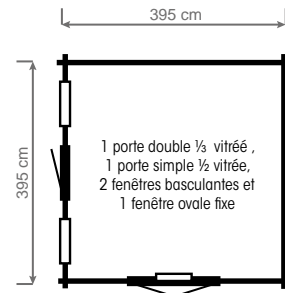









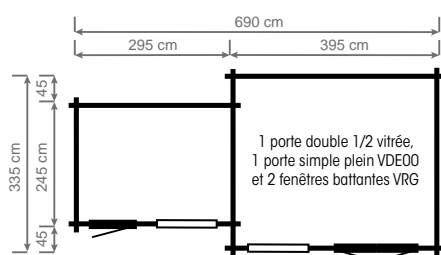

LOCRONAN



Annexe à droite pas inclus



 33-45-56 mm	 42°	 380 cm	 228 cm	 20 cm	 24 cm
 shingels					

COTTAGE & COUNTRY

AGANTON

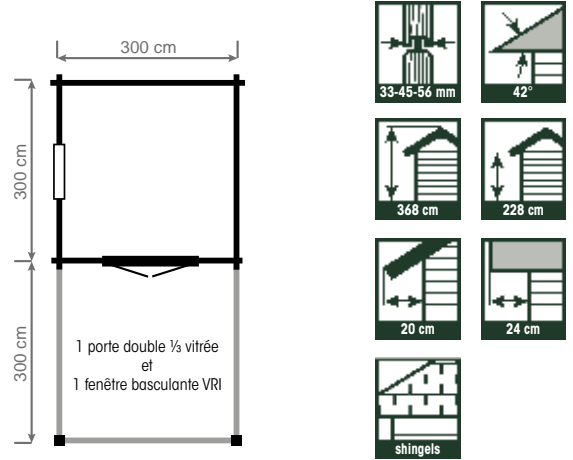

NERJA

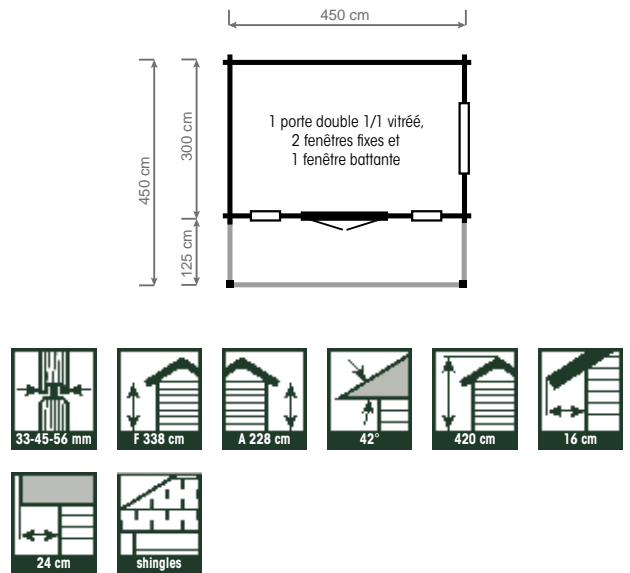

ZINGA

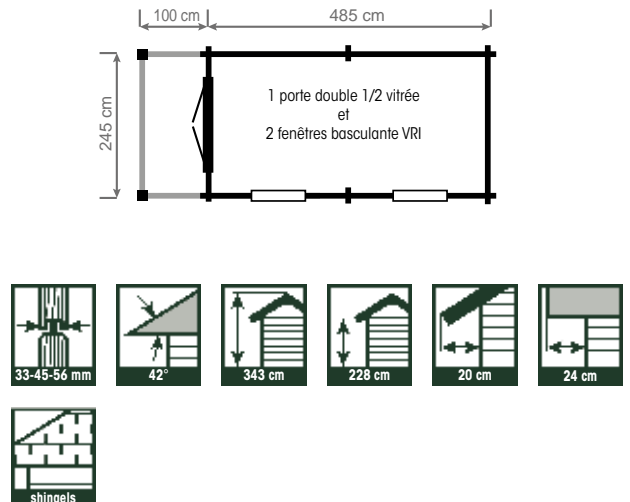









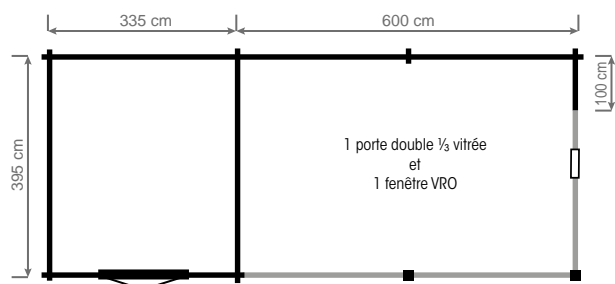

OREAN



set gouttières zinc en option



 33-45-56 mm	 42°	 424 cm	 241 cm	 20 cm	 24 cm
 shingels					

GRANGES





GRANGES

Nos pavillons déplacent votre séjour à l'air libre! Ils sont toujours fabriqués avec du bois d'épicéa de qualité et sont fournis avec un certificat d'authenticité !

Un pavillon Grandcasa peut également servir de carport ou de remise.

A vous le choix!

Le pavillon est généralement utilisé comme séjour extérieur, où il fait bon de se détendre en été comme en hiver !



AVANTAGES

- Toit asymétrique 19 - 34°
- Chevrons ouverts rustiques
- Épaisseurs de bois 33, 45, 56 mm
- Poteaux de soutien massifs de 14 x 14 cm
- Grand choix de revêtements de toit : shingles (4), panneaux profilés métalliques (4), panneaux de tuiles métalliques (5)
- En option : finition exclusive avec des panneaux de toit en chaume

GRANGES

ROSCOFF JUNIOR

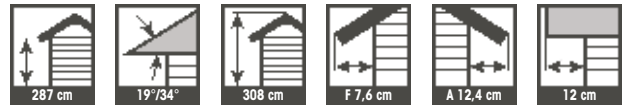
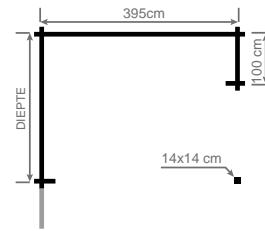

Disponible de 200 cm jusqu'à 485 cm de profondeur

ROSCOFF SENIOR / MASTER

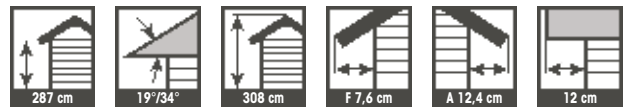
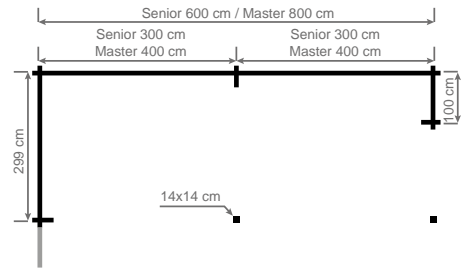

CROZON

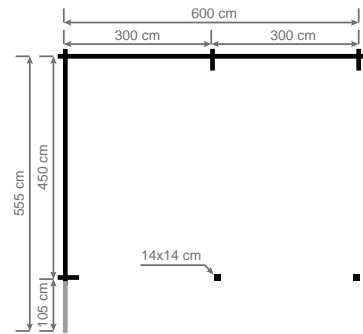



TREBERON

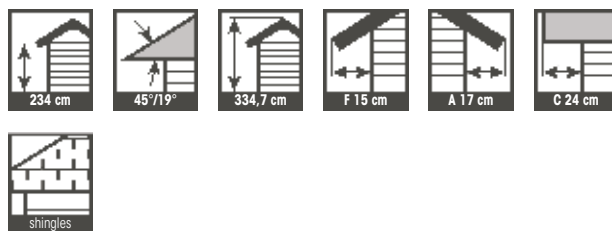
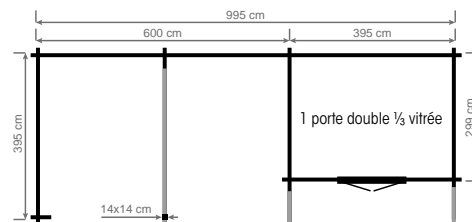

BÉNODET

porte simple en option

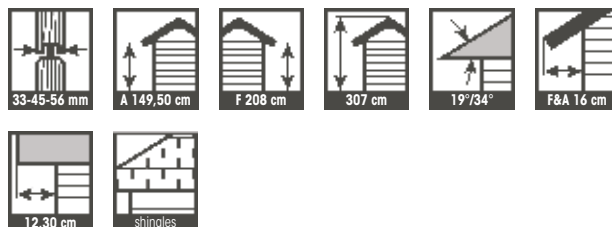
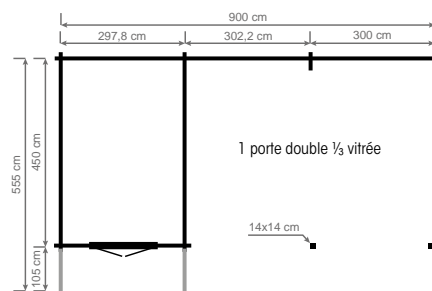

BATZ

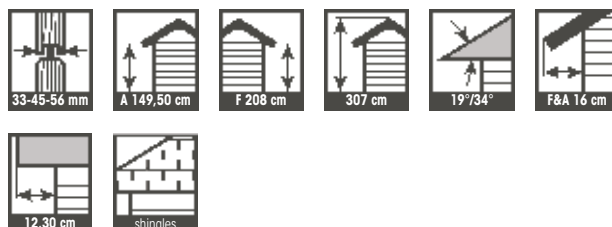
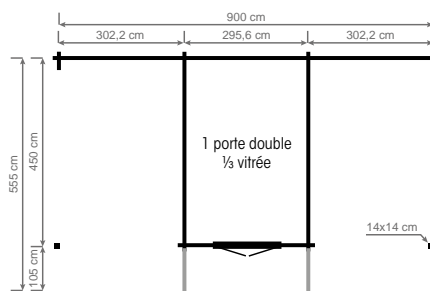

GRANGES

BERBER

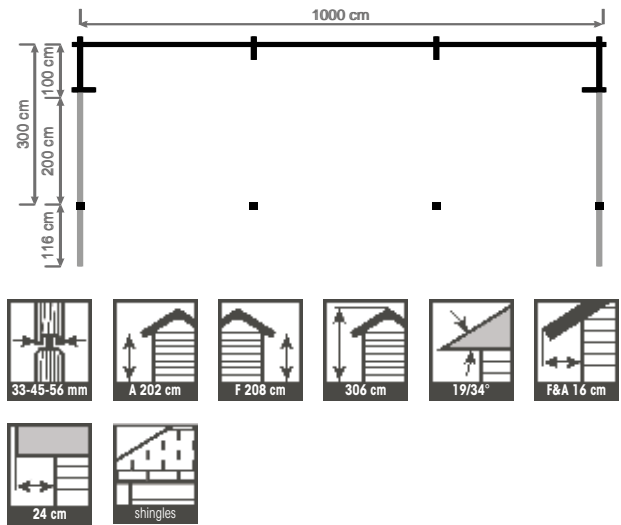

BRÉHAT

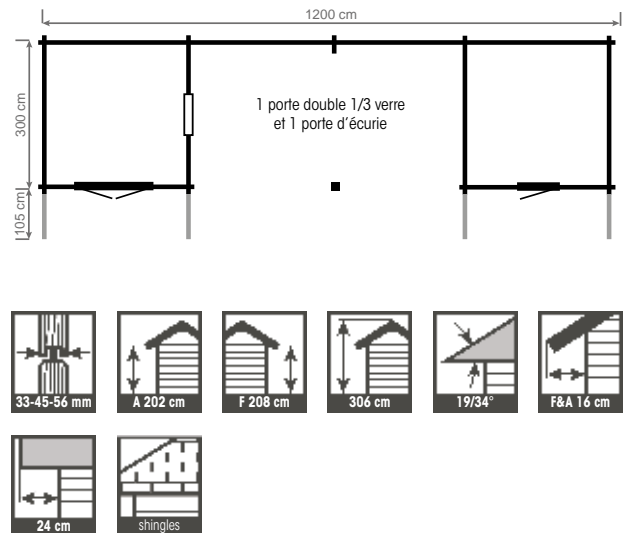



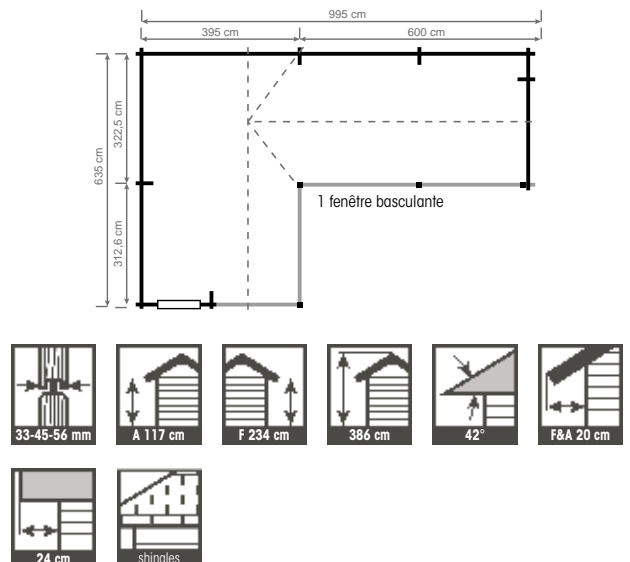



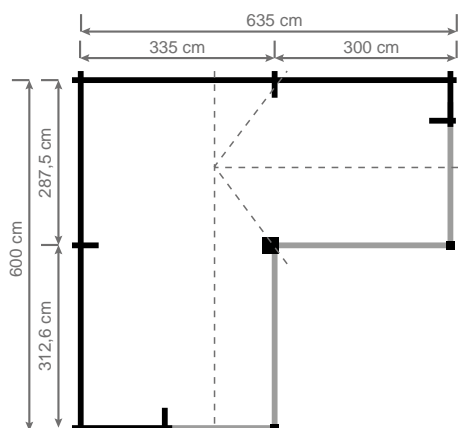

CALLOT





PAON



 33-45-56 mm	 208 cm	 42°	 278 cm	 F 24 cm	 A 24 cm
 16 cm	 shingles				



FENÊTRES ET PORTES

COMFORT LINE

AVANTAGES

- Porte laminée et soudée, ce qui neutralise l'effet naturel du bois (1)
- Fenêtres et portes rotatives vers l'extérieur
- Verre authentique de 4 mm d'épaisseur collé dans l'encadrement, avec de la silicone (2)
- Paumelles réglables intégrées (3)
- Petits-bois décoratifs
- Fenêtres avec garniture solide en aluminium
- Portes avec poignée massive en RVS (4)
- Portes doubles avec verrous à bascule intégrés
- Portes surélevées : 1960 mm (5)
- Possibilité de double vitrage 4-6-4 mm (6)
- Toutes les portes et fenêtres sont équipées de caoutchoucs d'étanchéité

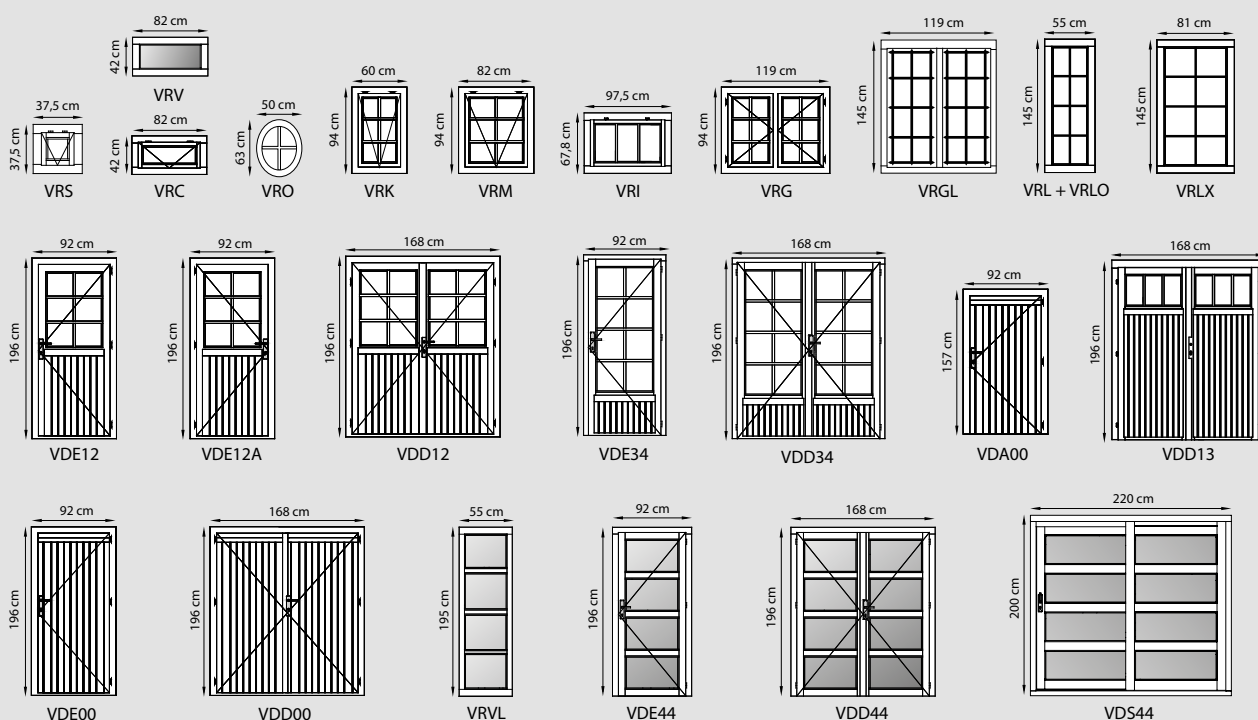



PREMIUM LINE

Super isolé et possible dans toutes nos constructions • qualité pour chalets de loisirs

AVANTAGES

- Fenêtres s'ouvrent vers l'intérieur
- Portes s'ouvrent vers l'extérieur
- Volets robustes disponibles en option, sur toutes les fenêtres et portes (1)
- Toutes les portes et fenêtres sont équipées de caoutchoucs d'étanchéité
- Petits-bois livrés en paquet. A installer librement
- Double vitrage de 4 - 16 - 4 mm prévu partout (2)
- Les panneaux de portes en bois sont équipés d'une isolation de 4 cm
- Serrure à cylindre avec fermeture à 3 points (3)
- Portes avec 4th charnière au sommet (4)
- Fenêtres ouvrantes sans pilier central (5)



2



4



- Bois multi-stratifié
- Minimise le fonctionnement naturel du bois
- Liaison hautement qualitative: résistant à l'eau

PLUS GRANDE STABILITÉ

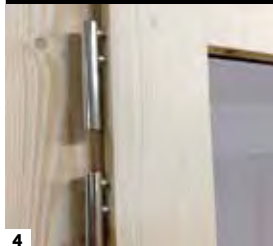

PLUS DE VISIBILITÉ



5



3



1

VOLETS

- Volets robustes optionnel (porte 22 mm, fenêtre 18 mm)
- Encadrement de porte 55 x 93 mm
- Charnières renforcées en forme de L, en acier peint
- Verrouillables de l'intérieur



1

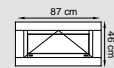

WRC

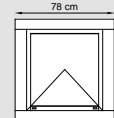

WRD

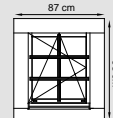

WRM

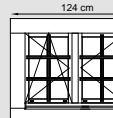

WRG

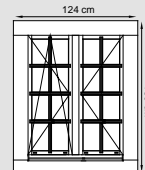

WRGL

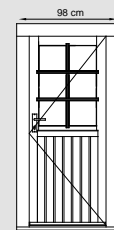

WDE12

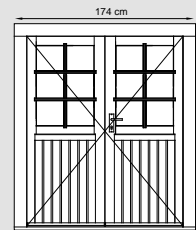

WDD12

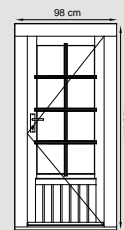

WDE34

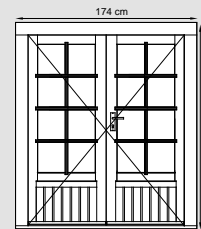

WDD34

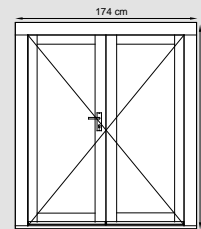

WDD11

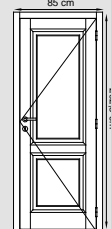

WDB00

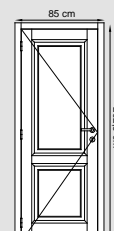

WDB00

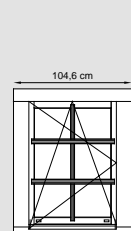

WRML

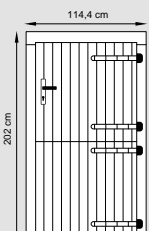

WPD

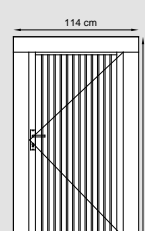

WDE00X



FENÊTRES ET PORTES

- ✓ **Vitrage isolant 4-16-4, Low-E;**
valeur $U_g = 1,1 \text{ W/m}^2\text{K}$
- ✓ **Isolation acoustique**
- ✓ **Parfaitement étanche à l'air et à l'eau**



SUPREME LINE ALUMINIUM

Gamme de fenêtres et portes en aluminium de qualité, avec système de cadre et pont de rupture thermique, coloris anthracite.

AVANTAGES

- Look industriel, valeurs U de 1,96 à 1,33 W/m²K
- Petits-bois décoratifs de 23,1 mm sur le vitrage.

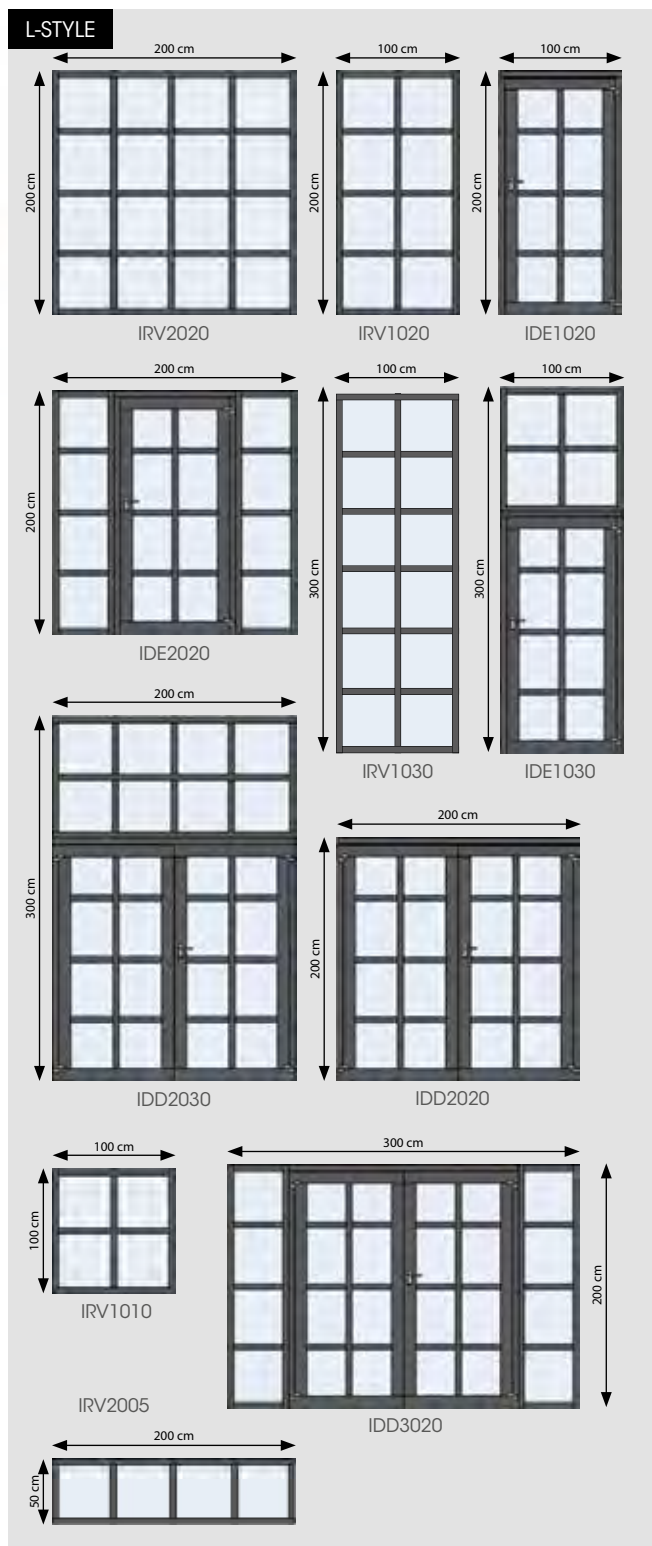



AVANTAGES

- Portes coulissantes et baies vitrées spacieuses avec vitrage isolant 9-16-4
- Poignées de porte et charnières également dans le ton anthracite
- Portes coulissantes avec mécanisme de coulissement, fermeture automatique et système contre les déformations



A-STYLE

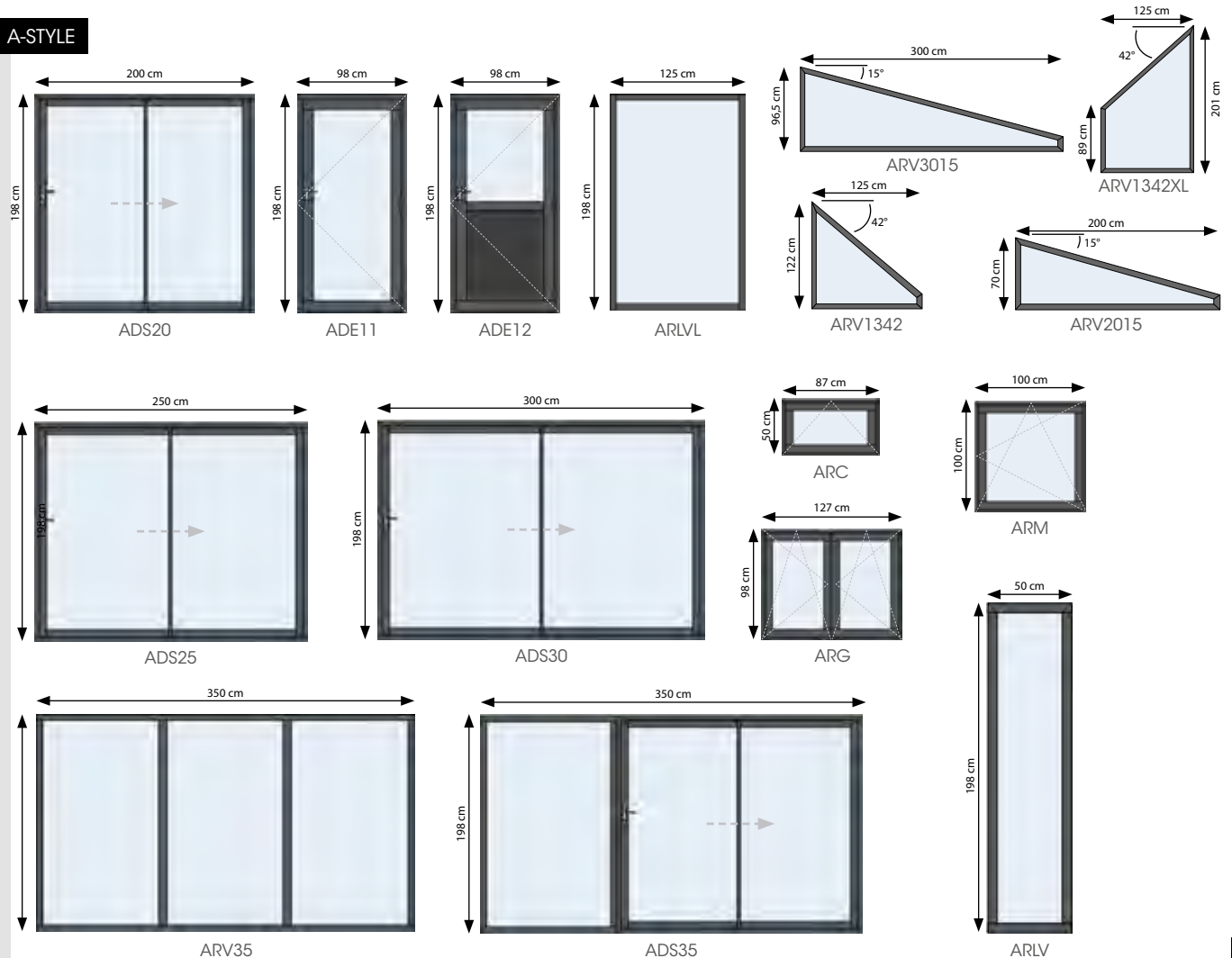

ROYAL





ROYAL

Soif de prestige, d'exclusivité, de luxe?
 Notre gamme Royal est faite pour vous.
 Le toit pyramidal très distingué des abris de
 jardin Royal crée en effet un look royal.
 Ces modèles sont aussi équipés en
 standard de portes 3/4 vitrées, combinées
 avec des fenêtres de la série VRL, raffinées
 elles aussi.
 Ces combinaisons garantissent un
 rayonnement raffiné et distingué.



AVANTAGES

- Toit pyramidal avec solives de 38 x 89 mm et de 33 x 145 mm, sous-toit avec planches massives de 19 mm et pré-assemblé en 8 parties
- Toiture : choix parmi pas moins de 4 variétés de shingles (vert, brun, noir, rouge)
- Possibilité d'exécution avec porte d'angle

ROYAL BASIC



Façade:	1 - 30 m
Profondeur:	1 - 6 m
Hauteur:	2,67 - 3,45 m
Fenêtres:	
Portes:	



ROYAL BASIC



OPTION: porte coulissante



OPTION: porte d'angle



Configurations possibles



ROYAL

ALBA

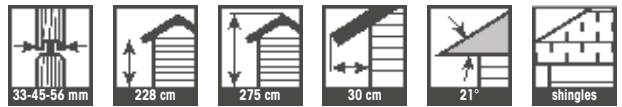
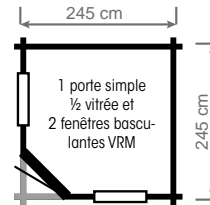

ARTHUR

set de gouttières en option

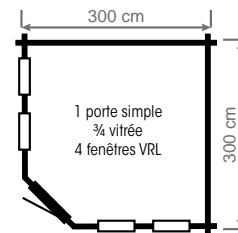

Porte d'angle, supportée par
2 profiles robustes (150 x 100 mm)

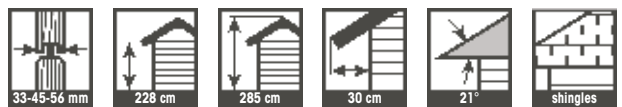

GEORGE

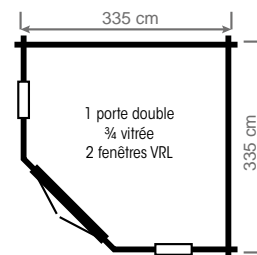

Porte d'angle, supportée par
2 profiles robustes (150 x 100 mm)





ACAPULCO

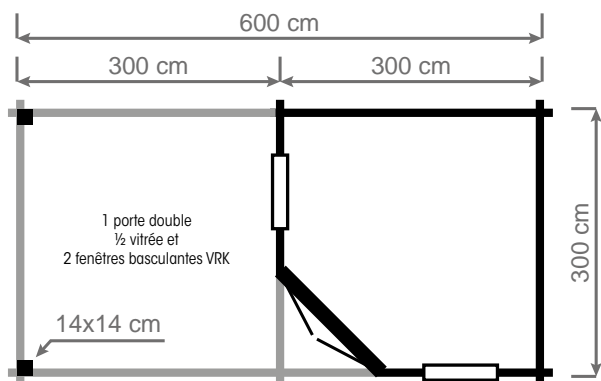

ROYAL

TORTUGA

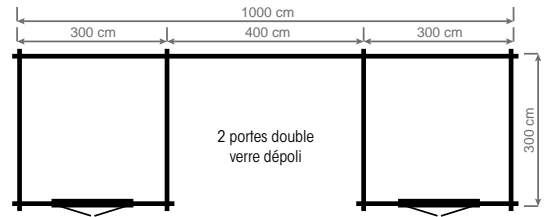

Terrasse couverte 400 x 300 cm



MERIDA

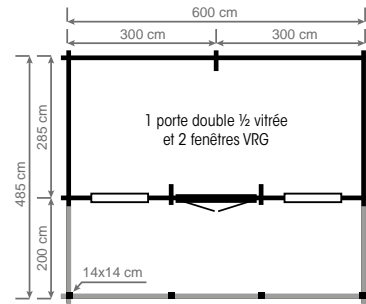

ORINOCO

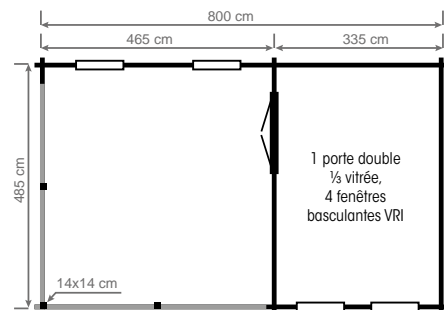



CALUMMA

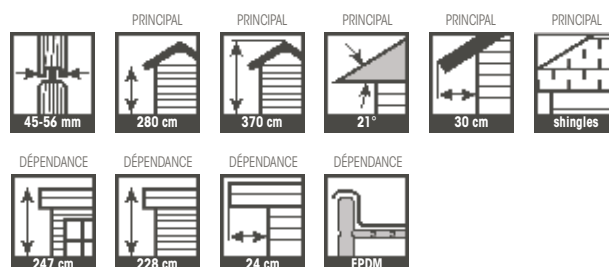
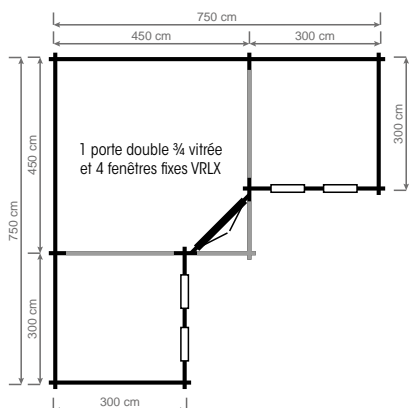

ROYAL

BONORI

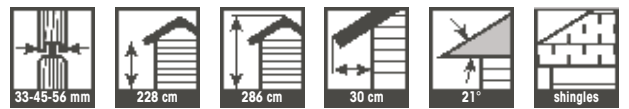
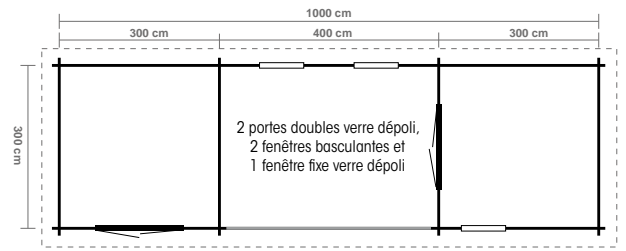

YUCATAN

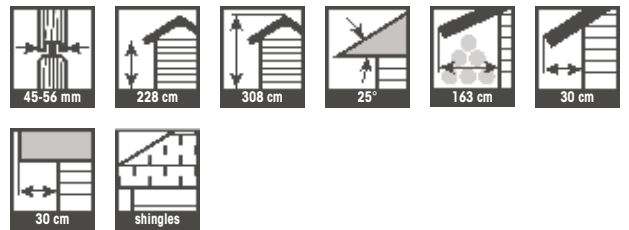
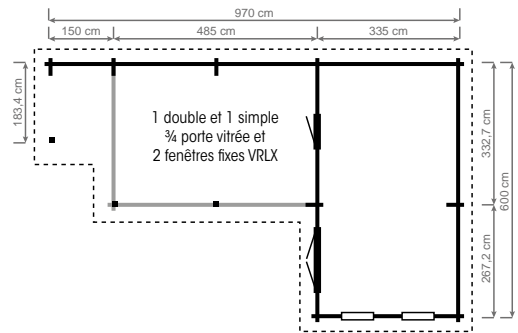

HIDALGO

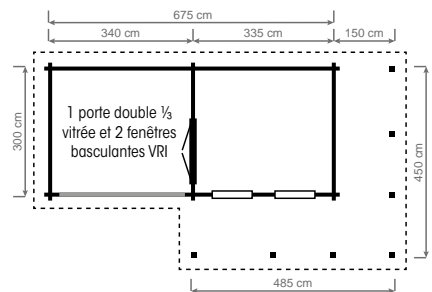



ANGUILLA

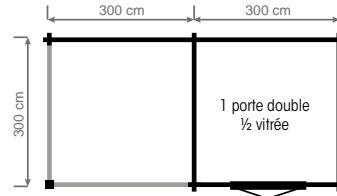

33-45-56 mm	228 cm	± 286 cm	21°	30 cm	shingles

GALLEROSA

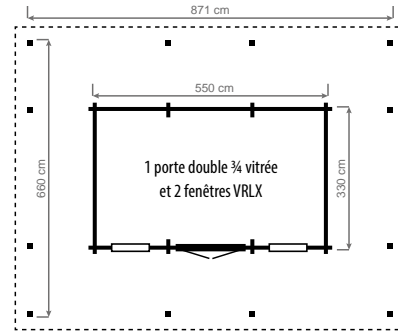

• Autour, terrasse couverte 195 cm, fourni avec poutres de support 14 x 14 cm

45-56 mm	240 cm	± 440 cm	25°	shingles

CURACAO

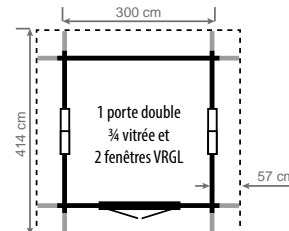

33-45-56 mm	228 cm	305 cm	21°	shingles



POUR LA GESTION DURABLE DES FORÊTS





Le **Programme de reconnaissance des certifications forestières** (PEFC) est une certification forestière promue par **PEFC International**, organisation non gouvernementale sans but lucratif, fondée à Paris en 1999 et dont le siège est situé à Genève. Il a pour objectif de promouvoir la gestion durable des forêts au travers d'une certification indépendante. Celle-ci concerne en tout deux tiers des forêts certifiées dans le monde. Plus de 15 millions de propriétaires forestiers privés ont adhéré à cette convention.

Tout notre bois est certifié PEFC, ce qui implique que le bois de votre construction provient de forêts où, chaque année, le nombre d'arbres abattus est inférieur au nombre d'arbres plantés. En outre, le label PEFC exige le respect de huit conventions centrales de l'OIT :

- N° 29 sur le travail forcé (1930)
- N° 87 sur la liberté syndicale et la protection du droit syndical (1948)
- N° 98 sur le droit d'organisation et de négociation collective (1949)
- N° 100 sur l'égalité de rémunération (1951)
- N° 105 sur l'abolition du travail forcé (1957)
- N° 111 concernant la discrimination (emploi et profession) (1958)
- N° 138 sur l'âge minimum (1973)
- N° 182 sur les pires formes de travail des enfants (1999)

Par ailleurs, nous appliquons les exigences d'autres conventions internationales relatives à la gestion des forêts, telles que les conventions sur la **biodiversité**, le protocole de **Kyoto sur le réchauffement climatique** et la CITES.

ÉCOLOGIQUE ET DURABLE

STYLE MONOPENTE





Style monopente

Notre collection exclusive de constructions de jardin avec des toits à pente simple est une parfaite symbiose entre la nature et l'architecture. En plus de l'esthétique et du savoir-faire, la fonctionnalité reste également extrêmement importante. Un toit en appentis est plus facile à entretenir et très efficace car l'eau et la neige sont évacuées d'un côté. De plus, une position optimale est possible dans la direction du soleil, ce qui rend ces constructions idéales pour l'installation de panneaux solaires.

REVÊTEMENT DE TOIT : NEW AGE

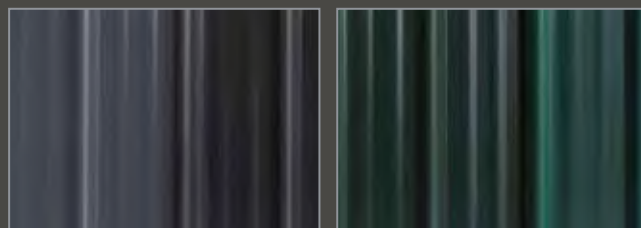

AVANTAGES

- Toit à simple pente possible à partir d'une inclinaison de 3°
- Différents revêtements de toit possibles tels que des panneaux profilés métalliques et des bardeaux Xtreme
- Large choix de fenêtres et de portes : confort en bois ou ligne premium et ligne Supreme en aluminium
- Épaisseurs de bois de 33, 45 ou 56 mm
- Débords de toit plus larges possibles

MONO STYLE

GOL

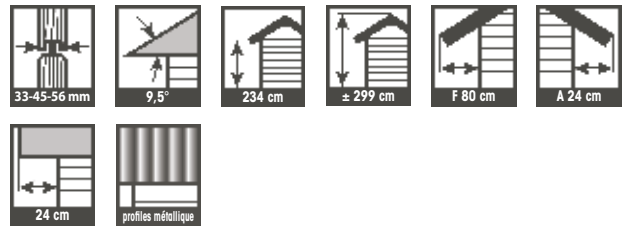
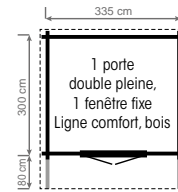

ATHOS

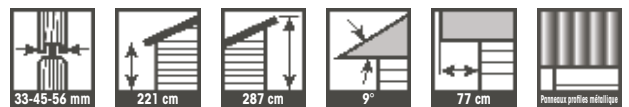
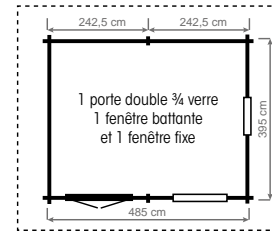



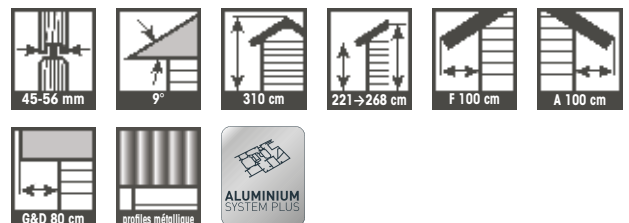
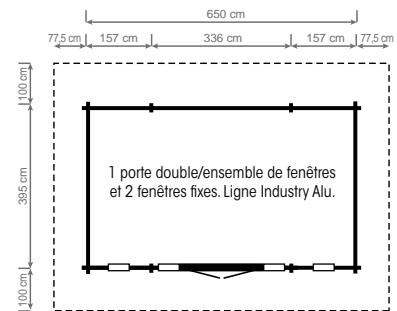





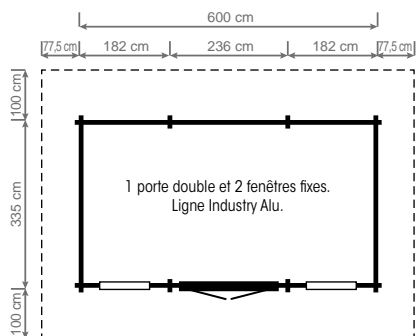

JOTUN





GRYIA



 45-56 mm	 17°	 377 cm	 234-338 cm	 F 100 cm	 A 100 cm
 G&D 80 cm	 profiles métallique	 ALUMINIUM SYSTEM PLUS			

MONO STYLE

NAVASSA

porte et fenêtres premium avec des volets en option

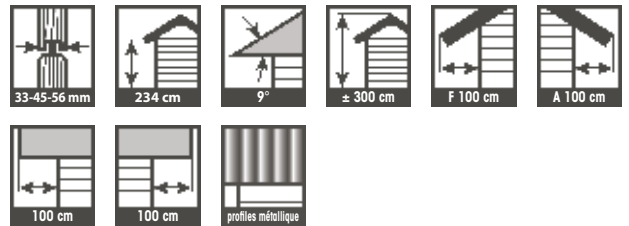
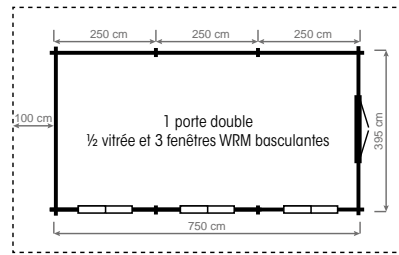

MONASTIR

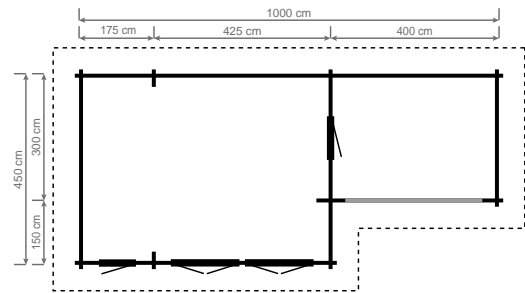

1 panneau de verre coulissant, 2 portes doubles WDD11, 1 porte plein Premium, 1 porte simple WDE34 et 1 fenêtre WRC



HULDRA

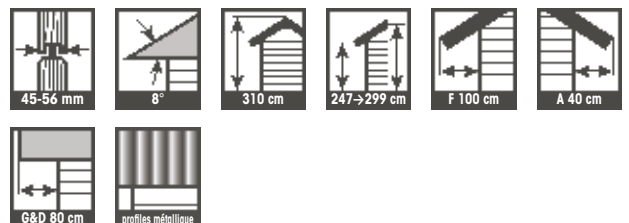
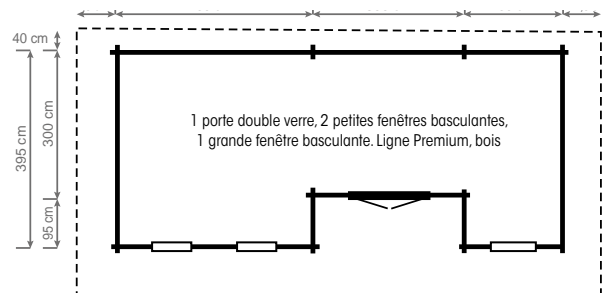



BORGU

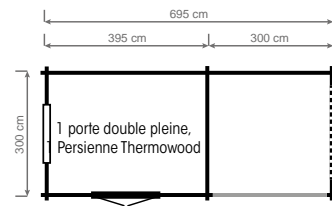

45-56 mm	15°	221 → 338 cm	± 325 cm	F 24 cm	A 24 cm
80 cm	shingles Xtreme	PERSIENNE			

VINCI

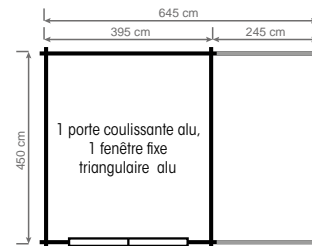

45-56 mm	15°	221 → 286 cm	± 398 cm	F 24 cm	A 24 cm
24 cm	shingles Xtreme	ALUMINIUM SYSTEM PLUS			

GARMO

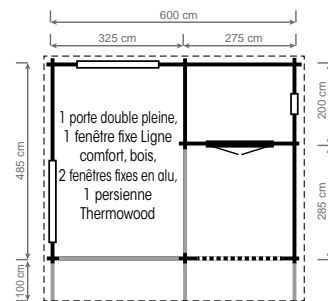

45-56 mm	9,5°	234 cm	± 273 cm	F 100 cm	A 24 cm
24 cm	profils métallique	ALUMINIUM SYSTEM PLUS		PERSIENNE	

MONO STYLE







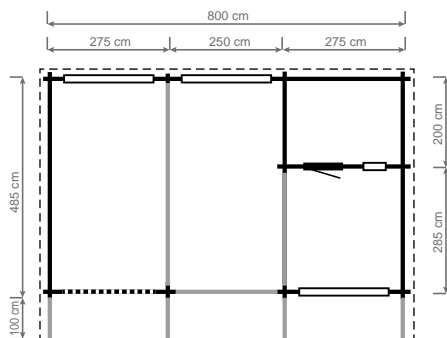

HEDDAL



STYLE MONOPENTE



1 porte double pleine, 1 petite fenêtre fixe Ligne confort,
4 fenêtres fixes alu, 1 persienne Thermowood

 45-56 mm	 9,5°	 234 cm	 ± 273 cm	 F 100 cm	 A 24 cm
 24 cm	 profils métallique				



UN TRAVAIL SUR MESURE EN 3 ÉTAPES

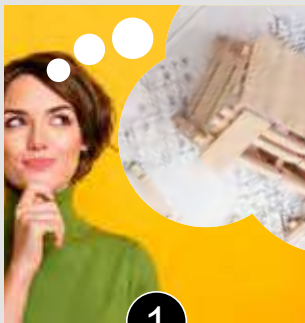

1

VOTRE IDÉE

Tout commence avec votre idée de la construction de vos rêves. Notre catalogue peut vous aider à trouver l'inspiration. Vous pouvez faire quelques dessins et/ou croquis.



2

CONTACTEZ-NOUS

Au **06.08.30.91.59**
en nous laissant un message si répondeur
ou par email à maisonboischalet@aol.fr
ou en nous rencontrant **à notre exposition.**
(voir adresse et horaires sur la dernière page)



3

VOTRE DEVIS PERSONNALISÉ

Nous traduirons vos souhaits de façon technique et évaluerons la faisabilité de votre projet.
Sur la base de cet entretien, nous vous remettrons un devis personnalisé du projet de vos rêves.

**DU SUR-MESURE À
DES PRIX STANDARDS**

- ✓ UN CERTIFICAT D'AUTHENTICITÉ
- ✓ AUCUN PRODUIT NE VIENT D'EUROPE DE L'EST, C'EST GARANTI !
- ✓ UN INTERLOCUTEUR DIRECT QUE VOUS POUVEZ RENCONTRER.

UN TRAVAIL SUR MESURE EN 3 ÉTAPES

87

CHALETS FORESTIERS

Cabins in the wood





CHALET FORESTIERS

Cabins in the wood

Notre nouvelle gamme se concentre sur ceux qui veulent embrasser la nature et séjourner au cœur de la forêt et des bois avec un minimum de luxe pour profiter de la splendeur naturelle que Mère Nature nous offre. Ces constructions se distinguent par leur apparence simple et leur conception pragmatique. Vous avez la possibilité d'opter pour de grandes baies vitrées dans un design alternatif ou non. Le point de chute idéal pour les chasseurs, les amoureux de la nature et les ornithologues.

FENÊTRES TRIANGULAIRES



AVANTAGES

- Différentes alternatives de formes de toit, telles que la toiture simple pente (7 à 9°), la toiture asymétrique à 2 pentes (7 et 15°) toit et éventuellement toit de chalet (42 °)
- Revêtement de toit : principalement des panneaux à profil métallique, mais en cas de pente >15°, des bardeaux sont également possibles.
- Fenêtres/portes isolées de la gamme Premium ou fenêtres/portes en aluminium de la gamme Supreme
- Épaisseur du bois 45 ou 56 mm
- Fenêtres triangulaires Alu à placer au-dessus de la corniche

CHALETS FORESTIERS

PIAKI

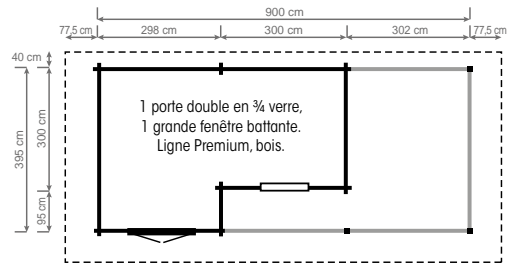

TIURI

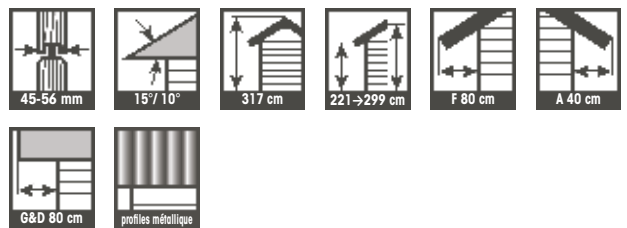
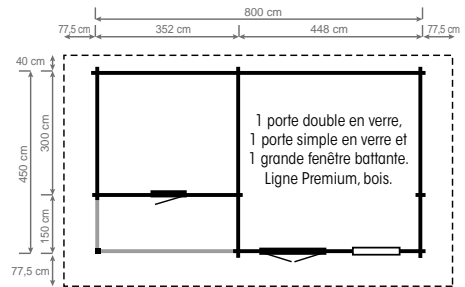



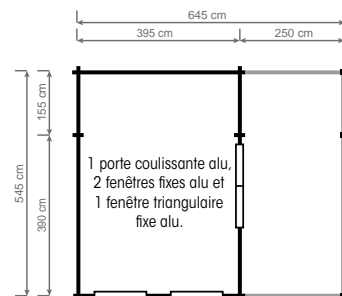





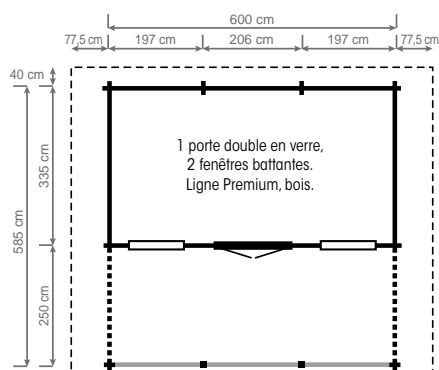

BRAGI





RISTRÌ



 45-56 mm	 15°/7°	 330 cm	 221 → 312 cm	 F 18 cm	 A 40 cm
 G&D 80 cm	 profiles métallique	 PERSIENNE			

CHALETS FORESTIERS

SERKUR

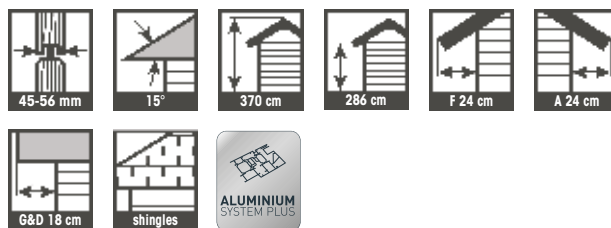
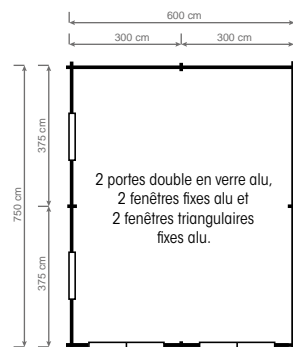

PICARIO

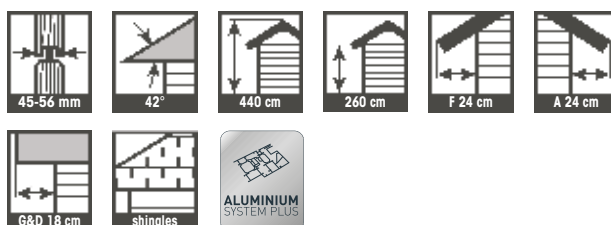



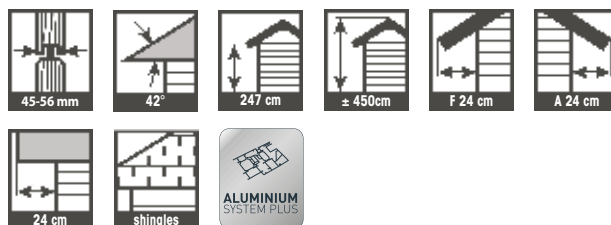
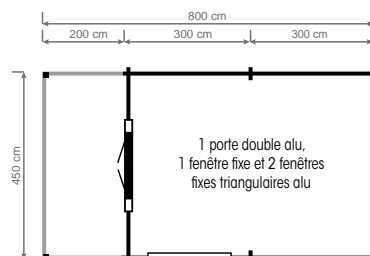





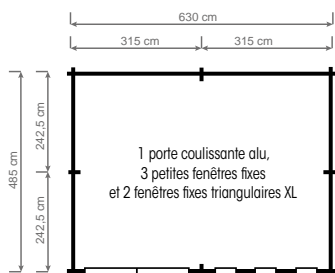

LIPSI





OLIVIA



 45-56 mm	 42°	 260 cm	 ± 527 cm	 F 24 cm	 A 24 cm
 24 cm	 shingles	 ALUMINIUM SYSTEM PLUS			

CHALETS FORESTIERS

MELOS

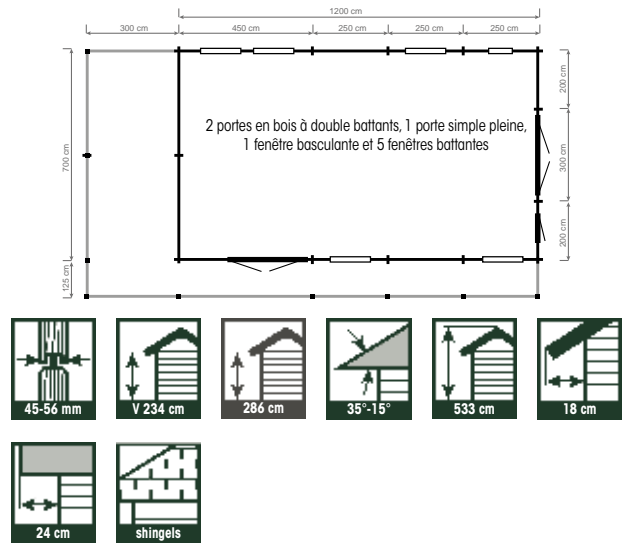

PAXI





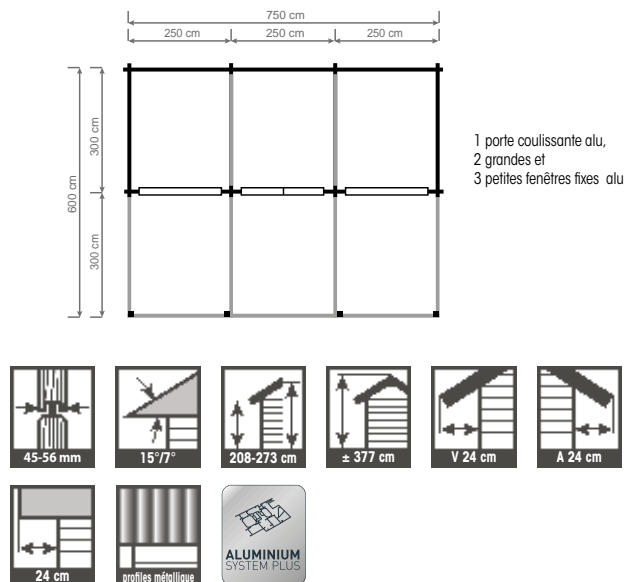





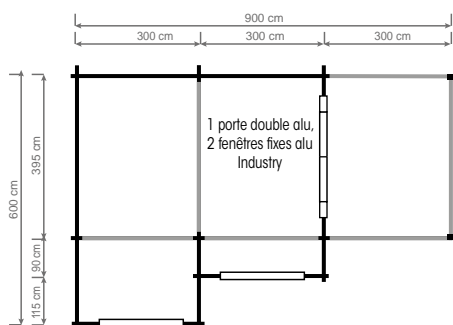

RINIA





FOUMI



- 
45-56 mm
- 
15°/7°
- 
208-299 cm
- 
± 345 cm
- 
V 24 cm
- 
A 24 cm
- 
24 cm
- 
profiles métallique
- 
ALUMINIUM SYSTEM PLUS

INDUSTRY





INDUSTRY

Le style industriel, également appelé « Industrial chic », fait référence à une tendance en matière de design intérieur qui consiste à récupérer des éléments d'anciens bâtiments manufacturiers récemment convertis en lofts. Parmi les éléments de ce style, citons les matériaux authentiques (bois vieilli, etc.), des matériaux bruts, de grandes baies vitrées, des tons simples et rustiques (comme les tintes de gris), etc. Nous avons tenté de cristalliser une atmosphère d'entrepôt au sein de cette ligne de produits.

ALUMINIUM fenêtres/portes



AVANTAGES

- Gamme de fenêtres et portes industrielles dans un style de loft
- Épaisseur du bois 45 et 56 mm
- Vitrage isolant 4-16-4 HR+ ; valeur $U_g = 1,1 \text{ W/m}^2\text{K}$
- Fenêtres et portes à rupture de pont thermique
- Coloris anthracite des fenêtres / portes
- Toutes formes de toit possibles

INDUSTRY

JENSON

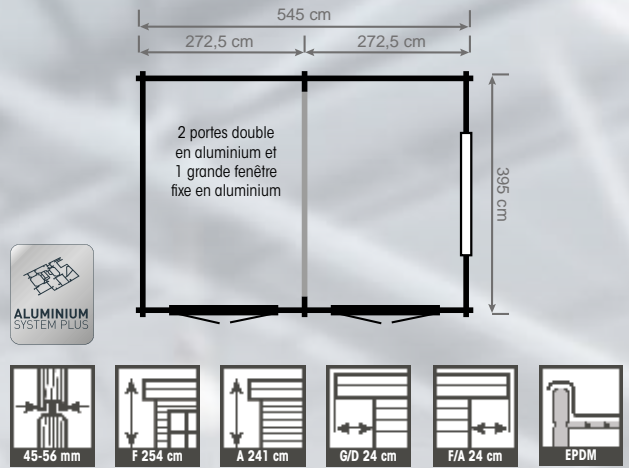

GIMSON

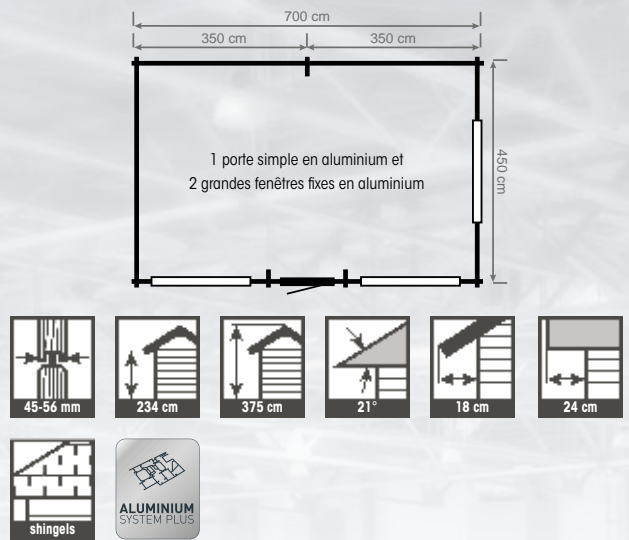

DRESSER

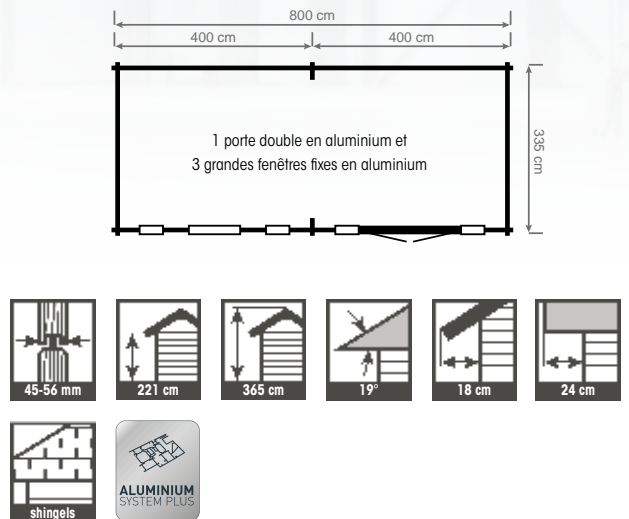



TUDOR



KELMOT

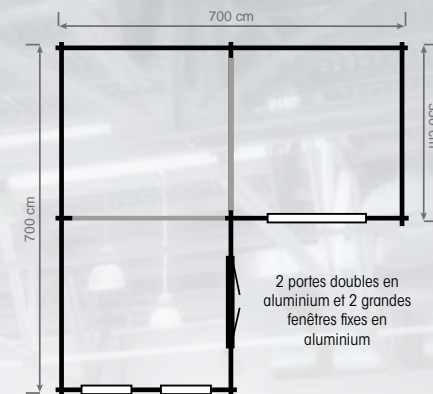

PRIOR

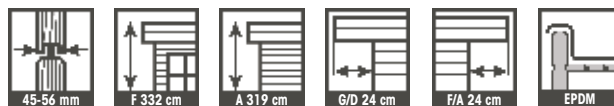
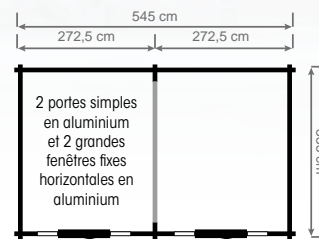

INDUSTRY

RAM

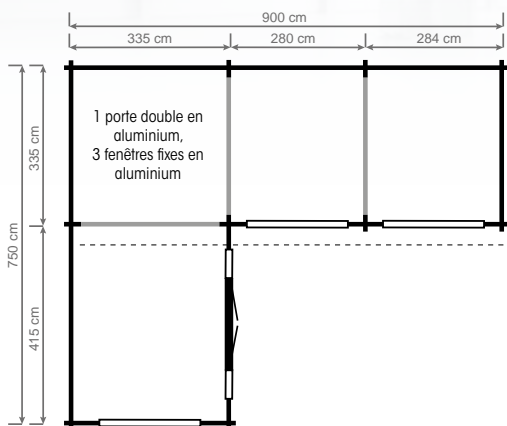









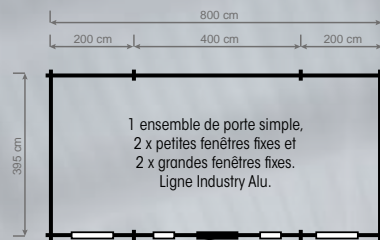

INDUSTRY

100









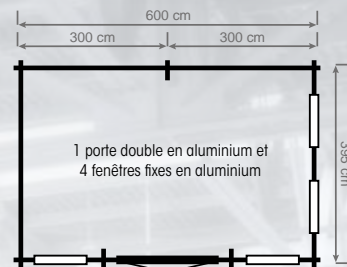

PEACOCK



	PRINCIPAL 	PRINCIPAL 	DÉPENDANCE 		
					







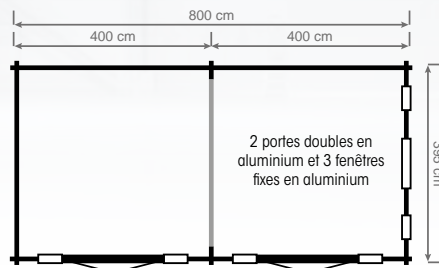

GODMAN



WALKER



					
					

INDUSTRY

MENDINI

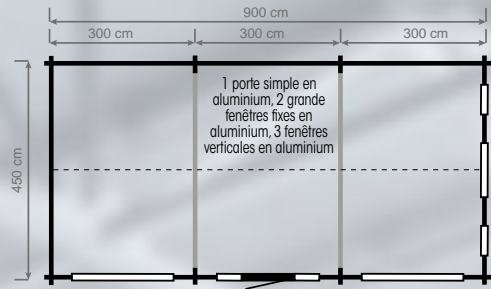

DAWSON

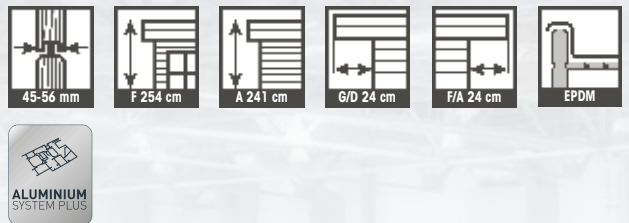
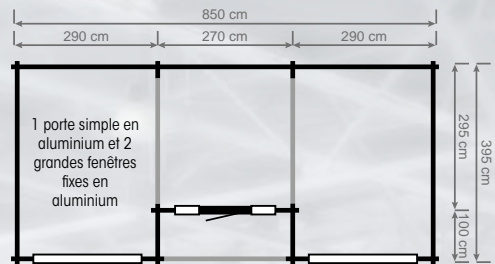

TRABZON

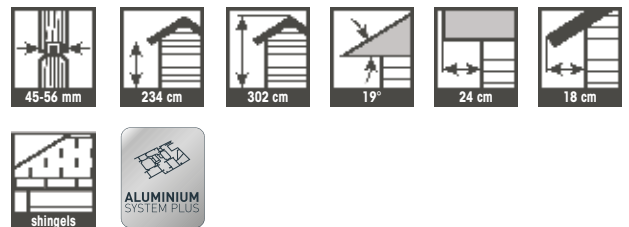
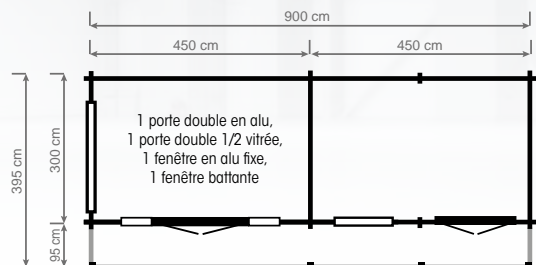



RUSKIN



MORRIS

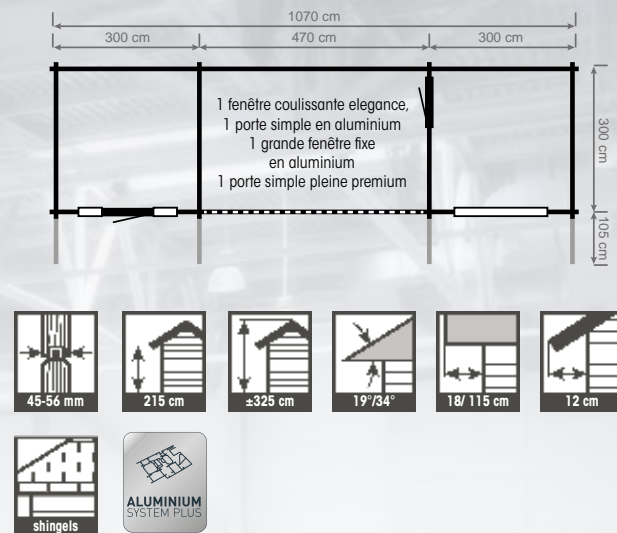

COLANI

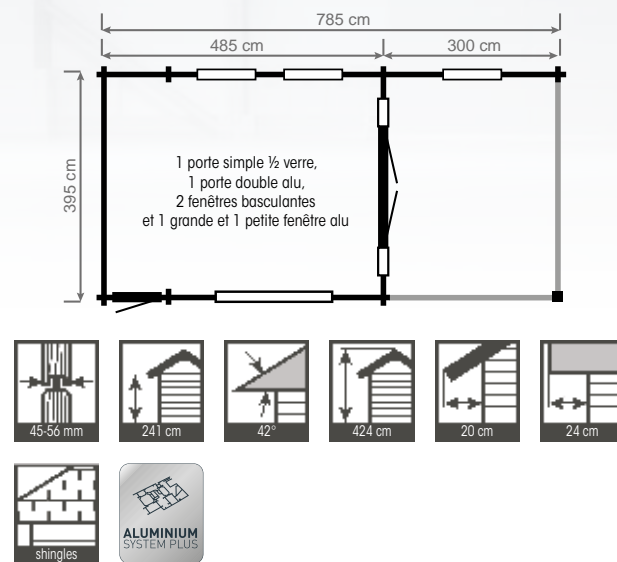

INDUSTRY

EMI

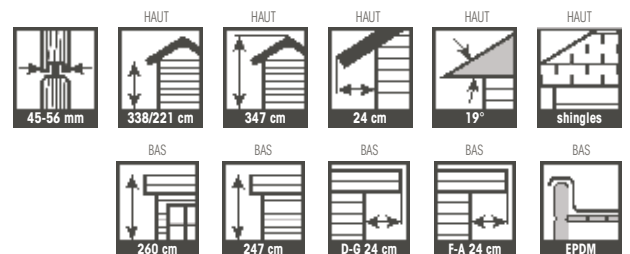
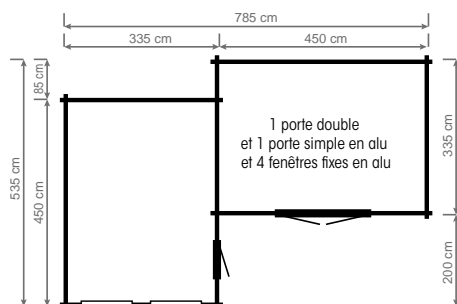



COUVERTURE DU TOIT PREMIUM

TOITURE PRESQUE PLATE (mini pente)



N°1

N°3

Devis en 2 semaines environ

PANNEAUX PROFILÉS MÉTALLIQUES

- Panneaux métalliques massifs et galvanisés
- Revêtement en polyester-silicone 25 microns
- 4 coloris : gris **N°1**, anthracite **N°2**, vert foncé **N°3**, vert **N°4**

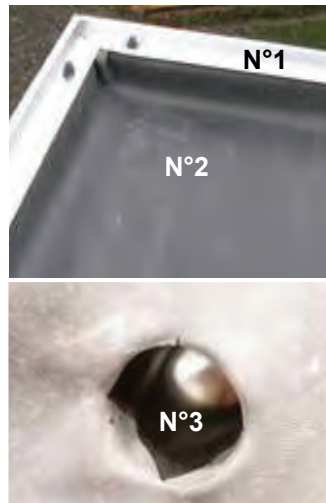

Standard

EPDM EN CAOUTCHOUC AVEC PROFILÉS EN ALUMINIUM

- Caoutchouc EPDM 400% élastique **N°2**
- Certifié ATG
- Résistant aux UV et à l'ozone
- Sans le moindre entretien et 100% recyclable
- Finition avec des profilés en aluminium élégants **N°1** de 35 x 45 mm
- Angles pré-montés
- Avaloir pour égouttage et gouttières **N°3**
- Toiture standard

TOITURE AVEC 1 ou 2 PENTES

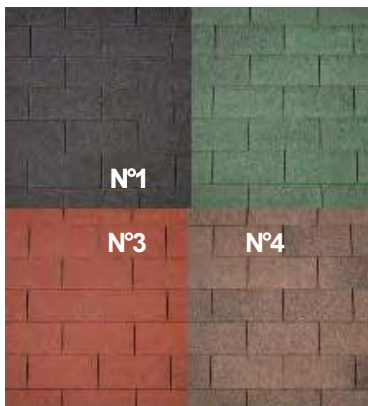

N°1

N°3

N°4

Standard sur les toits en 1 ou 2 pentes si pentes au min. de 26.79% (15°)

SHINGLES BITUMÉS

- Shingles épais en asphalte et fibre de verre
- 4 couleurs : noir **N°1**, vert **N°2**, rouge/bordeaux **N°3**, brun **N°4**
- Toiture standard

Option sur les toits en 1 ou 2 pentes, mais obligatoire si pente comprise entre 14.05% (8°) et 26.79% (14.99°)



PANNEAUX EN BAC ACIER IMITATION TUILES

- Acier de qualité suédoise
- Résistant au gel, à la chaleur, à la grêle et à la tempête
- Auto-nettoyants, pas de formation de mousse
- Disponibles en 5 couleurs :
- noir **N°1**, gris anthracite **N°2**, brun **N°3**, cloudy terracotta **N°4** et Terracotta **N°5**



N°1

N°2

N°3

N°4

N°5



Devis en 2 semaines environ

ARDOISES OU CASSEROLES

- Pignon de toit / façade adapté
- Tous les types possibles
- Vue authentique



Devis en 2 semaines environ

SHINGLES CAMBRIDGE

- Shingles double couche en asphalte et fibre de verre
- L'allure authentique des 'cottages' anglais
- Couleur : brun

NOUVEAU



Devis en 3 semaines environ

CAMBRIDGE XTREME

- Bardeaux doubles autoadhésifs
- Couleur : Gris Harvard Slate
- Possible à partir de 9,5°

Caractéristiques spéciales

- Résistance plus impressionnante à la pluie dirigée par le vent
- Revêtement de toit résistant aux conditions météorologiques extrêmes

ABRIS DE SALON

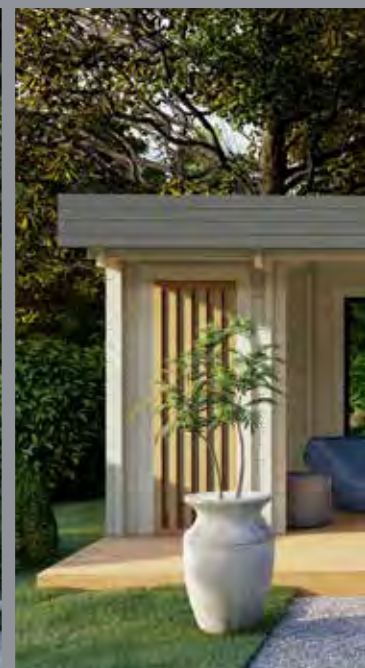
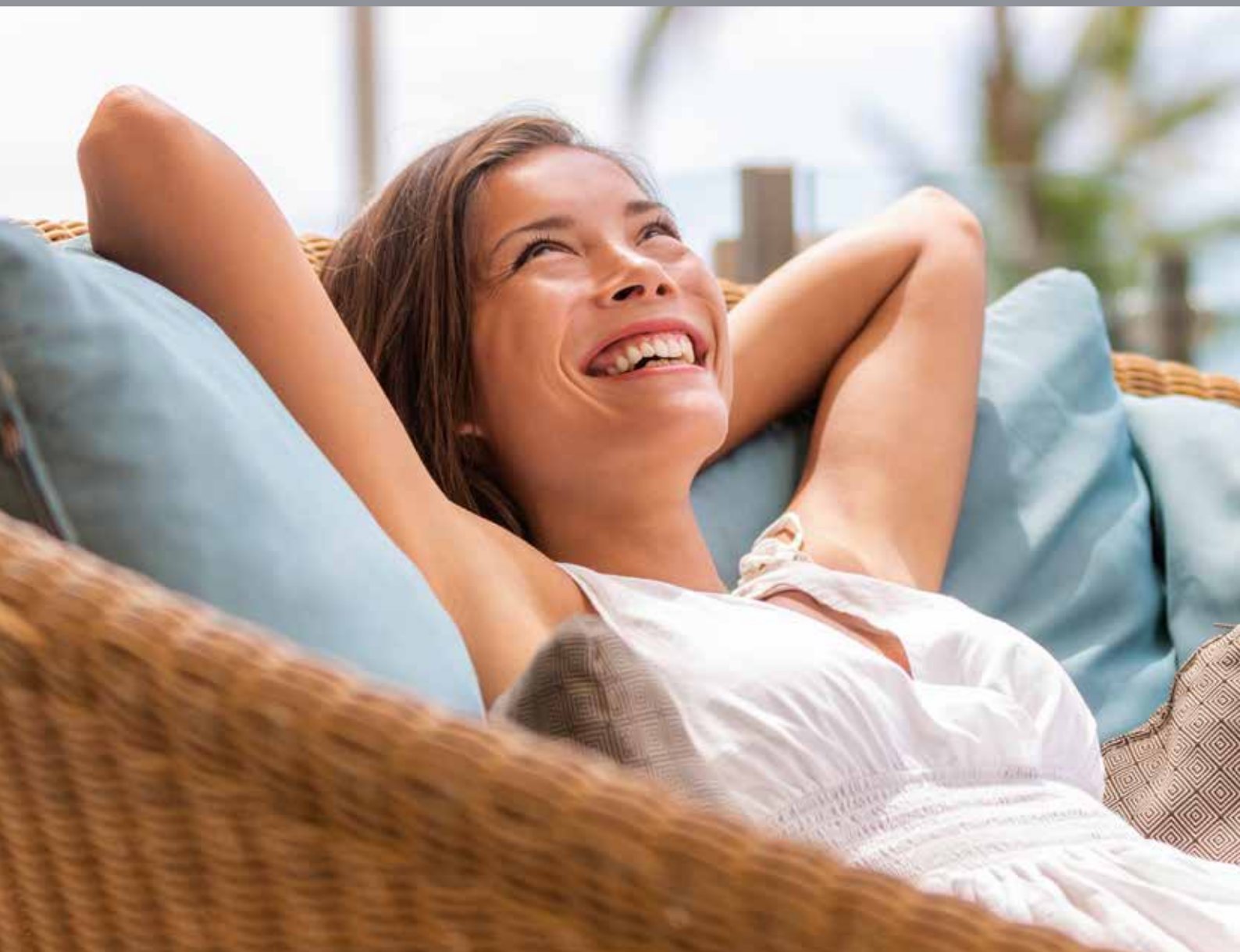



ABRIS DE SALON

Le jardin se veut de plus en plus le prolongement de la pièce de vie. Rien de tel que de s'y reposer, y partager un repas, y faire du cocooning... Et de préférence dans un cadre agréable aménagé avec élégance et bon goût. Nos modèles de salons de jardin offrent à ce titre la solution idéale. Des pavillons modernes semi-ouverts parsemés de magnifiques persiennes en Thermowood qui ne demandent aucun entretien. Rêvez les yeux ouverts et laissez libre cours à votre fantaisie.

Persienne en Thermowood



AVANTAGES

- Toit plat finition EPDM et profils alu en inox
- Épaisseur du bois 45 ou 56 mm
- Persiennes en poutres Thermowood de 56 x 118 mm. Interstices de 56 mm
- En option : puits de lumière 80 x 200 cm en verre de sécurité en polycarbonate trempé
- En option : terrasse avec revêtement antidérapant 28 x 145 mm

ABRIS DE SALON

SOCO

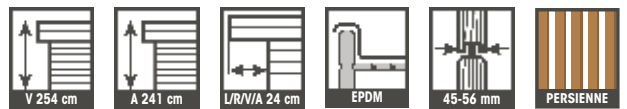
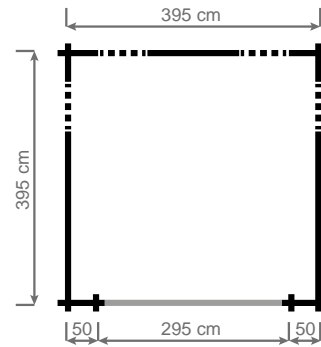

KLEIN

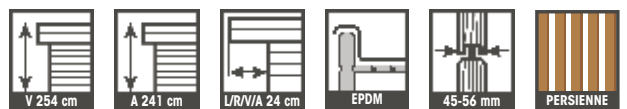
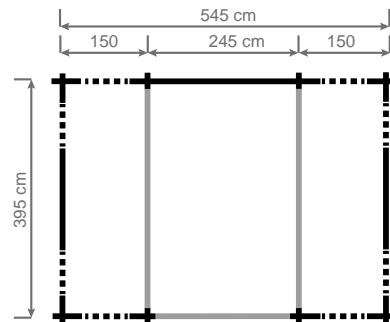

SHAPIRO

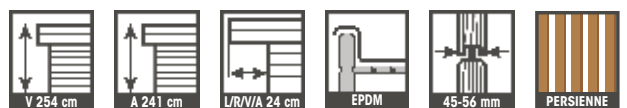
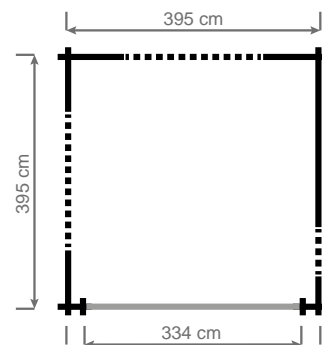



JUDE

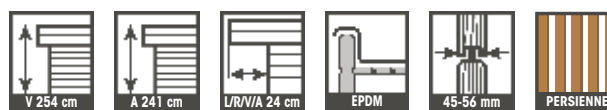
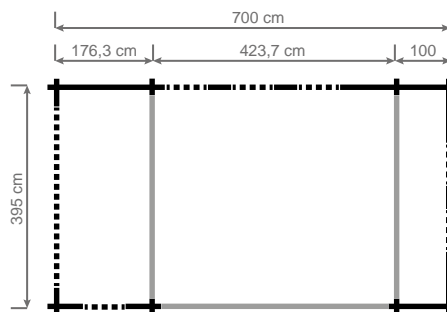

AMAYA

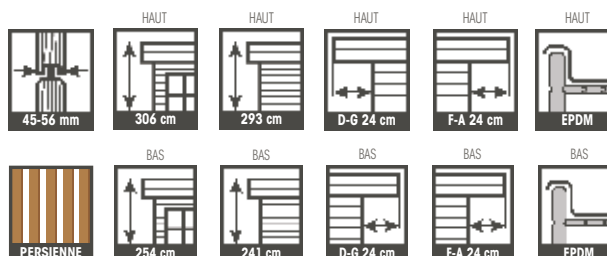
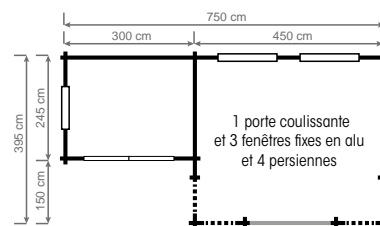

AKIRA

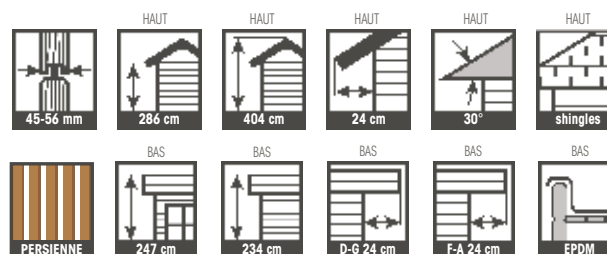
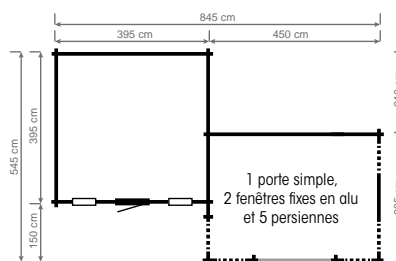

ABRIS DE SALON

CORSE

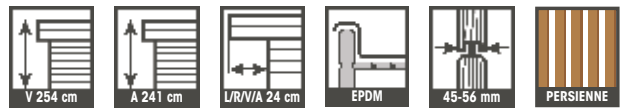
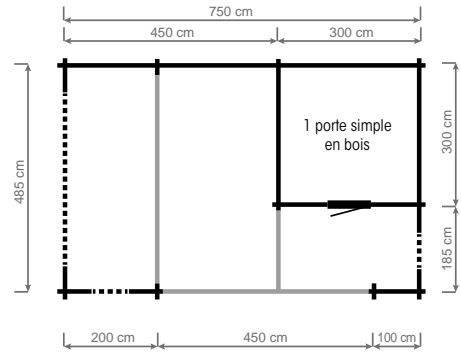

ULMAN

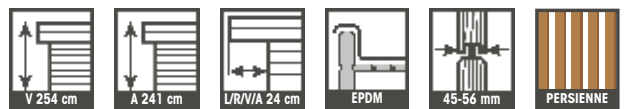
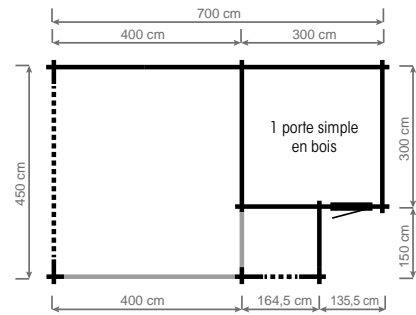

LONG

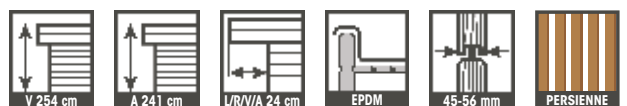
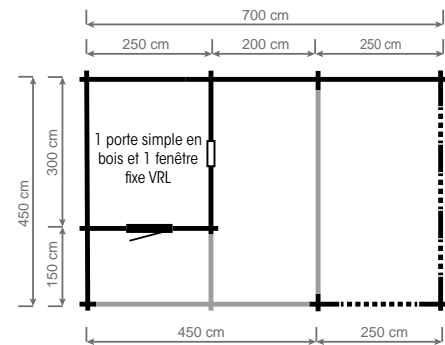



UFAN

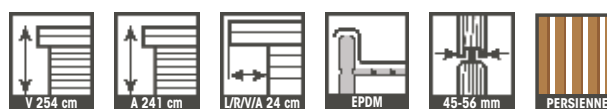
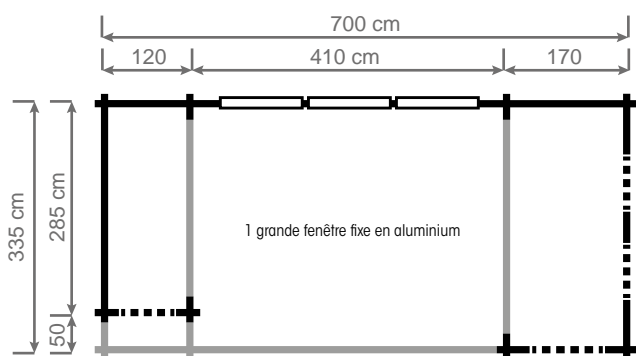

ABRIS DE SALON



SERRA

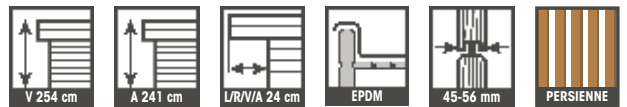
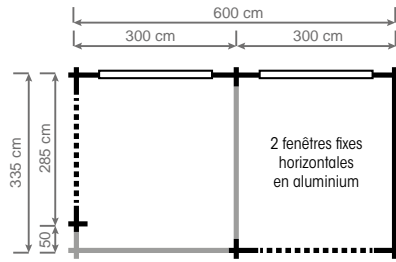

MIKI

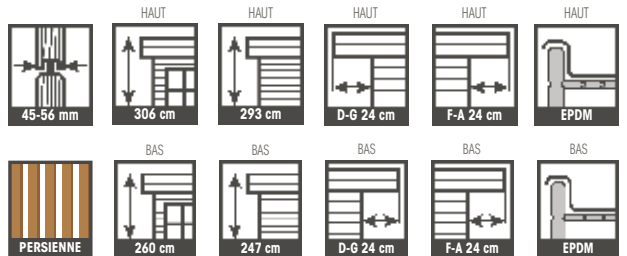
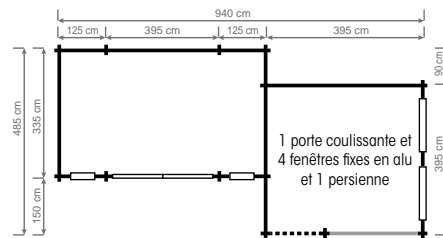

HIKU

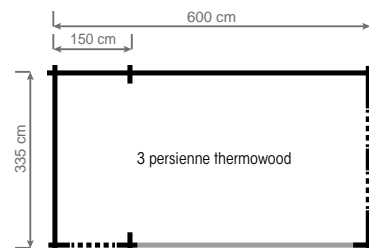



PRODUITS DE CHEZ NOUS



CERTIFICAT D'AUTHENTICITE



Par ce certificat on déclare que la construction Grandcasa, objet du bon de commande....., est une production authentique originaire du site de production à Elversele, Belgique, et également produit selon la norme de qualité Force Plus pour les profils en coupe-vent.

Ce certificat garantit également que la construction mentionnée ci-dessus est construite avec du bois qualitatif-pin, originaire du Nord de l'Europe, livrée conforme à la norme NEN(5466) avec le certificat KOMO correspondant et certifiée PEFC (CoC N° CTIB-TCHN 0938).

Elversele - Belgique, 2025

Emis par:
Pontweg 9C - 9140 Elversele - Belgique



CERTIFICAT D'AUTHENTICITÉ = CERTIFICAT D'ORIGINE

Un certificat d'authenticité est en réalité un certificat d'origine. De cette manière, nous vous garantissons que votre chalet Grandcasa est un produit d'origine qui provient de nos manufactures et a été produit dans les pays du Benelux selon le principe des profilés de chalet coupe-vent, notre label de qualité Force Plus.

Ce label de qualité garantit également l'origine et la qualité du bois. Les chalets de la marque Grandcasa sont aussi certifiés PEFC.

Le certificat d'origine de nos chalets vous garantit que votre chalet a été produit en suivant un processus de production de qualité conforme aux normes occidentales avec du bois de qualité, cultivé dans le respect de l'environnement. Nous avons développé ce certificat d'authenticité parce qu'il existe sur le marché des produits bien meilleur marché, mais de qualité moindre, fabriqués en Europe centrale et/ou de l'Est selon un processus de fabrication douteuse et avec du bois de moins bonne qualité. Souvent, la vraie qualité du produit est passée sous silence, mais le client apprend tôt ou tard les conséquences désastreuses de son choix. Nous vous conseillons donc d'acheter un chalet avec un certificat d'origine. Au final, vous ferez des économies. Méfiez-vous des copies bon marché provenant d'Europe de l'Est.

DEMANDEZ TOUJOURS VOTRE CERTIFICAT D'AUTHENTICITÉ! Faites attention aux constructions inférieures de l'Europe de l'Est

SERVICE ET GARANTIE

Notre service après-vente français est disponible 5 jours sur 7, du matin au soir. Nos services de production et service après-vente réservés à nos professionnels se situent en Belgique, à proximité de nos clients.

PROFIL IMPERMÉABLE AU VENT DU BOIS DE QUALITÉ

- Double fraisage
- Les plus grandes rainures et languettes du marché. 15 mm assure une plus grande robustesse



Les chalets Grandcasa sont fabriqués avec du pin de qualité provenant d'Europe du Nord, selon les normes NEN 5466, et ils sont livrés avec un certificat KOMO. Le froid fait pousser ces arbres plus lentement, ce qui rend le bois plus solide et permet de garantir une durée de vie bien plus longue à nos chalets.

WELLNESS SAUNA





WELLNESS SAUNA

Détendez-vous ! Notre gamme de saunas modernes et de qualité qui est un vrai délice pour le corps et l'esprit. Tous les éléments indispensables au sauna sont fabriqués en aulne, une essence européenne d'excellente qualité. L'aulne possède une longue durée de vie que la présence d'eau et d'humidité allonge encore. Les bâtiments historiques reposent souvent sur des pieux en aulne. Grâce aux propriétés exceptionnelles de ce matériau, vous profiterez de moments de détente dans votre sauna conçu sur mesure durant de nombreuses années.

AVANTAGES

- Parois de 56 mm d'épaisseur, une épaisseur de 45 mm est également possible
- Convient comme sauna intérieur ou extérieur
- Porte design en verre de sécurité (8 mm) avec poignée et encadrement en aulne (69 x 192 cm)
- Doté de 2 éléments d'aération, dont un coulissant

Bois d'aulne : doux, résistant et fort.
Plus fort que le cèdre



WELLNESS SAUNA

EGER

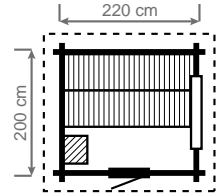

1 porte sauna et 1 fenêtre horizontale



OBUDA

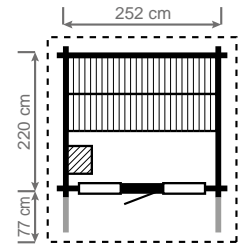

1 porte sauna et 2 fenêtres verticales

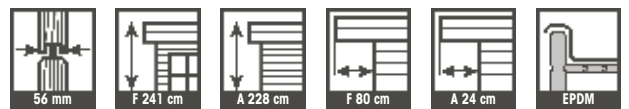

SOBOTA

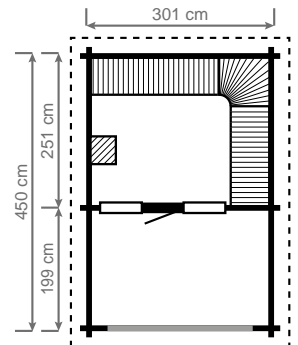

1 panneau de verre coulissant,
1 porte sauna et 2 fenêtres sauna verticales





ZALAKA

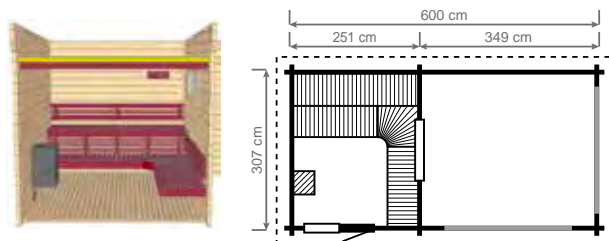

2 panneaux de verre coulissants, 1 porte sauna et 1 fenêtre sauna horizontale



HARKANY

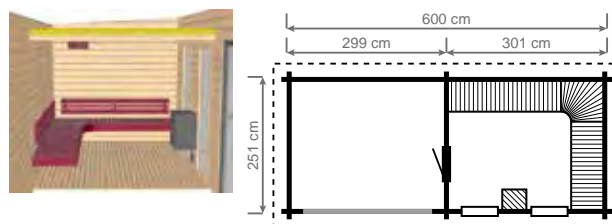

1 panneau de verre coulissant, 1 porte sauna et 2 fenêtres sauna verticales



SAVAR

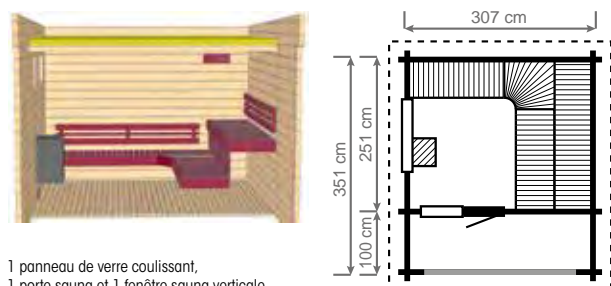

1 panneau de verre coulissant, 1 porte sauna et 1 fenêtre sauna verticale et 1 horizontale



WELLNESS SAUNA

VILLANY

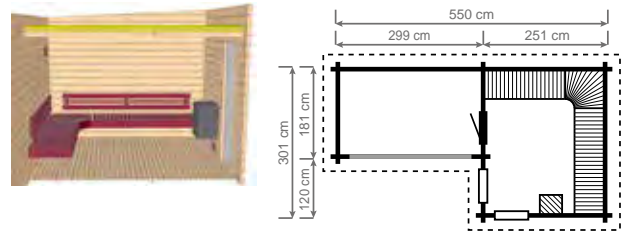

1 panneau de verre coulissant, 1 porte sauna et 2 fenêtres sauna verticales



TAMBURA

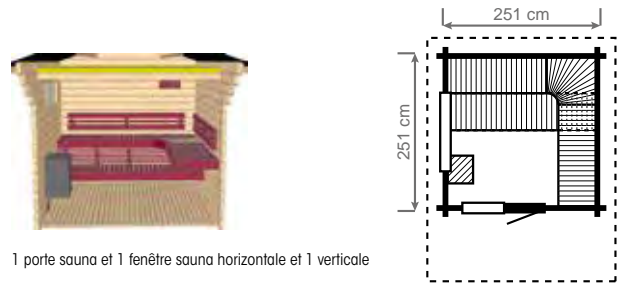

1 porte sauna et 1 fenêtre sauna horizontale et 1 verticale



MOHAC

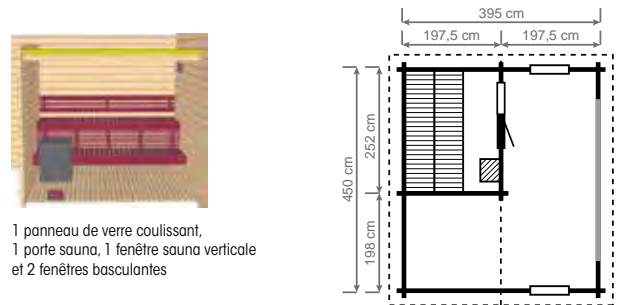

1 panneau de verre coulissant, 1 porte sauna, 1 fenêtre sauna verticale et 2 fenêtres basculantes

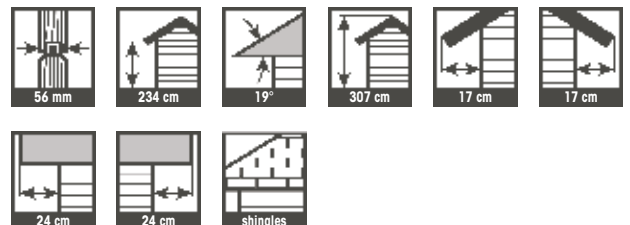

ACCESSOIRES EN POÊLES

ÉCLAIRAGE



EXTRAITS AROMATIQUES



INTÉRIEUR SAUNA



BANC

14 x 60 x 160-210-240 cm



DOSSIER

2,8 x 30 x 235 cm



THERMO- ET HYGROMÈTRE



SABLIER



PORTES ET FENÊTRES DE SAUNA

PORTE

- 69 x 192 cm
- verre de sécurité bronze de 8 mm
- encadrement et poignée en aulne avec serrure à rouleau intégrée

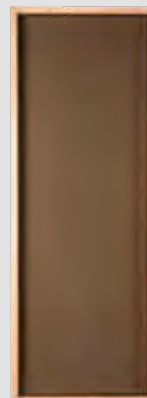

FENÊTRE VERTICALE

- 69 x 192 cm
- verre de sécurité bronze de 8 mm avec de l'aulne

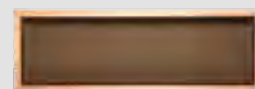

FENÊTRE HORIZONTALE

- 120 x 40 cm
- verre de sécurité bronze de 8 mm avec de l'aulne

APPUIE-TÊTE



GRILLE D'AÉRATION



PIERRES POUR SAUNAS



20 KG

SEAU ET LOUCHE EN MÉTAL



CHAMPAGNE



GRIS



GOUDRON

TYLÖ-HELO VIENNA

- Poêle de sauna classique de qualité avec panneau de commande intégré à la base, temps de fonctionnement de 3 heures.
- Ce poêle est programmable jusqu'à 9 heures à l'avance.
- Puissance de 6,6 ou 8 kW.
- Le poêle peut uniquement être fixé au mur.
- **Unique** à raccorder sur du 1 x 240 V, 3 x 240 V ou 400 V + N.



100%
FABRICATION
ET DESIGN
SUÉDOIS



TYLÖ SPORT

- Mêmes fonctionnalités que le Tylö-Helo Vienna
- Protection contre les contacts, ne chauffe pas, sécurité enfants
- Protection extérieure Thermosafe
- Modèle mural ou à poser (avec pieds)

SHE SHED



SHE SHED

120



SHE SHED

Les hommes doivent avoir leur espace, mais les femmes aussi. De nombreuses femmes très occupées ont besoin d'un endroit pour se reposer ou s'adonner aux activités créatives. Les femmes méritent certainement leur propre zone de confort et pourquoi pas en sirotant un gin tonic. Un bon nombre de pièces de vie sont des petits havres de paix. Aménagés avec de sympathiques fauteuils et peints dans des tons apaisants, ils offrent beaucoup de lumière naturelle et sont entourés de verdure. Laissez-vous inspirer par nos pièces de vie sur mesure.

AVANTAGES

- Plusieurs formes de toit possibles
- Épaisseur du bois 33,45 et 56 mm
- Poteau décoratif Athéna 14 x 14 cm en silhouette
- Puit de lumière 80 x 200 cm en verre de sécurité en polycarbonate trempé, haute résolution du bruit (-39 db)



Poteau
décoratif
Athéna
14 x 14 cm



OPTION: puit de lumière



SHE SHED

BÉATRICE

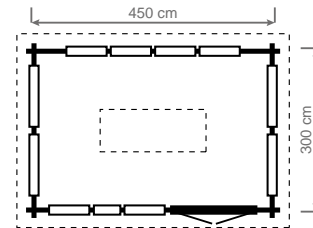

1 porte double ¾ vitrée, 4 fenêtres VRGL, 6 fenêtres VRLX fixe, 3 fenêtres VRL fixe et 1 puit de lumière

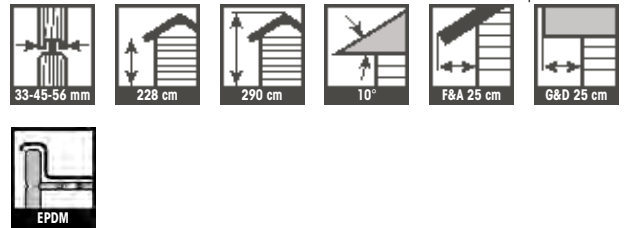

CAMILLA

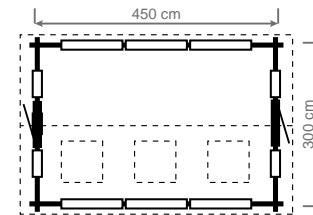

2 portes simples ¾ vitrée, 6 fenêtres VRGL, 4 fenêtres VRL fixe, 1 fenêtre VRS, 3 fenêtres de toit WRD

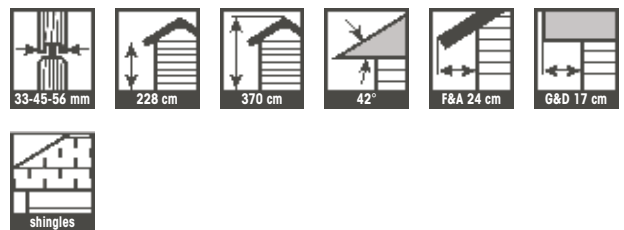

DIANA

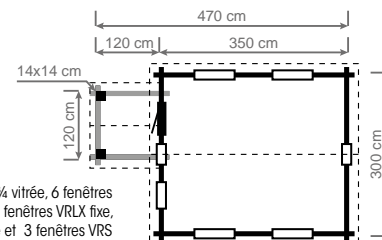

1 porte simple ¾ vitrée, 6 fenêtres VRGL, 4 fenêtres VRLX fixe, 1 fenêtre VRL fixe et 3 fenêtres VRS

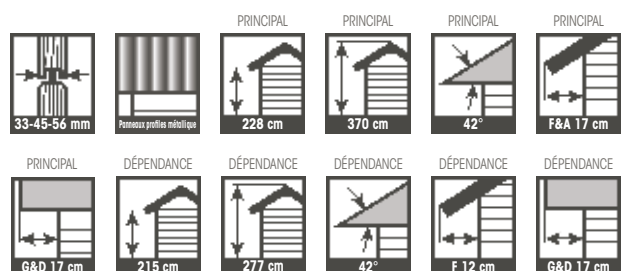



VICTORIA

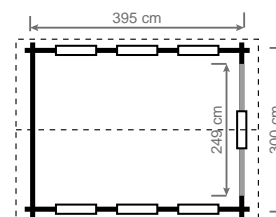

6 fenêtres fixe VRLX et 1 fenêtre ovale fixe VRO

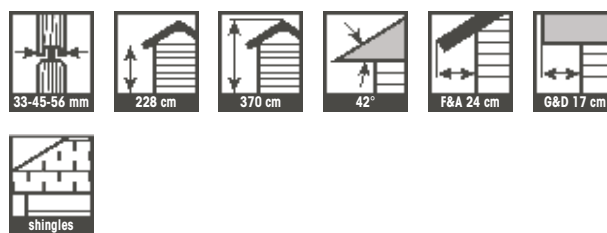

LOUIZA

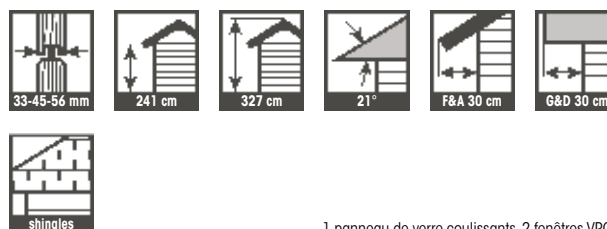
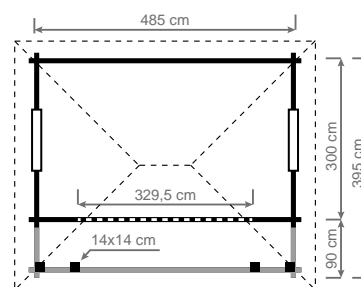

1 panneau de verre coulissants, 2 fenêtres VRGL

PAULINE



1 porte simple ¼ vitrée,
2 fenêtres VRLX fixe

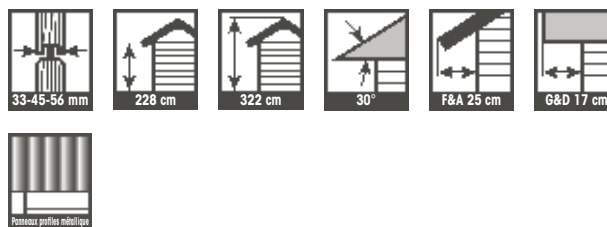
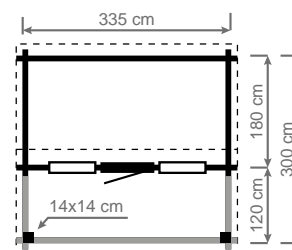

SHE SHED

KATARINA

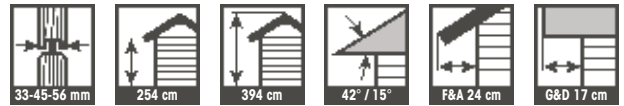
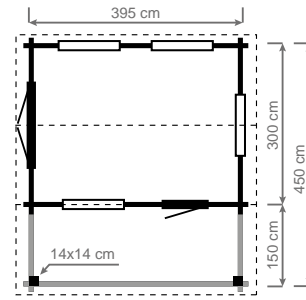

1 porte double ¾ vitrée, 1 porte simple ¾ vitrée,
4 fenêtres VRGL et 1 fenêtre ovale VRO fixe

FADIVA

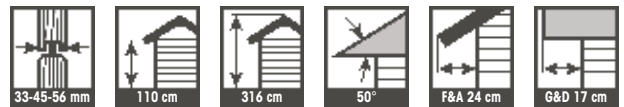
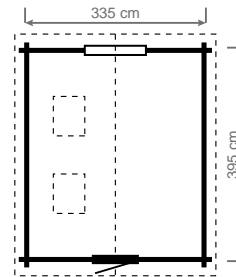

1 porte simple ¾ vitrée, 1 fenêtre VRGL,
4 fenêtres VRLX fixe, 2 fenêtres de toit WRD

JOSEPHINE

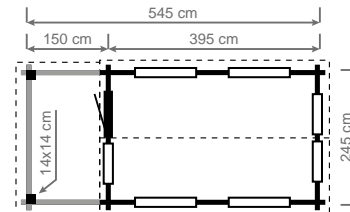

1 porte simple ¾ vitrée,
4 fenêtres VRGL, 3
fenêtres VRLX fixe
et 1 fenêtre ovale
VRO fixe

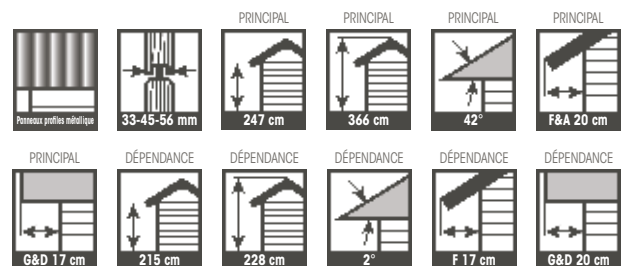



UN TRAVAIL SUR MESURE EN 3 ÉTAPES

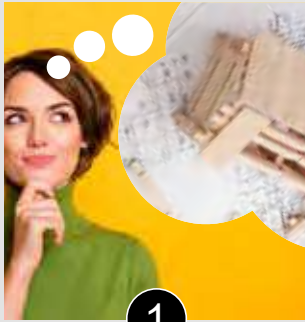

1

VOTRE IDÉE

Tout commence avec votre idée de la construction de vos rêves. Notre catalogue peut vous aider à trouver l'inspiration. Vous pouvez faire quelques dessins et/ou croquis.



2

CONTACTEZ-NOUS

Au **06.08.30.91.59**
en nous laissant un message si répondeur
ou par email à maisonboischalet@aol.fr
ou en nous rencontrant **à notre exposition.**
(voir adresse et horaires sur la dernière page)

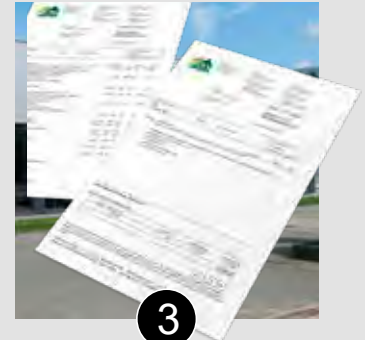

3

VOTRE DEVIS PERSONNALISÉ

Nous traduirons vos souhaits de façon technique et évaluerons la faisabilité de votre projet. Sur la base de cet entretien, nous vous remettrons un devis personnalisé du projet de vos rêves.

**DU SUR-MESURE À
DES PRIX STANDARDS**

- ✓ UN CERTIFICAT D'AUTHENTICITÉ
- ✓ AUCUN PRODUIT NE VIENT D'EUROPE DE L'EST, C'EST GARANTI !
- ✓ UN INTERLOCUTEUR DIRECT QUE VOUS POUVEZ RENCONTRER.

STYLE RURAL





STYLE RURAL

Un brin de nostalgie. Tout le monde se souvient des westerns avec leurs petits hameaux typiques et leurs villages de chercheurs d'or. C'est dans ce cadre que nous avons puisé l'inspiration pour notre gamme Farm. Caractéristique du genre, les portes à double battant et les portes et fenêtres protégées par des volets aussi robustes qu'esthétiques. Une gamme nostalgique et originale qui vient prendre à contrepied les constructions souvent très modernes. La dure vie au grand air, un retour à la nature.

Grandes portes à double battant



AVANTAGES

- grandes portes à double battant de 114,5 cm x 202 cm
- vaste choix de revêtements de toit: bardeaux, panneaux de tuiles, panneaux profilés métalliques
- épaisseur du bois 45 ou 56 mm
- portes et fenêtres haut de gamme avec volets fonctionnels

STYLE RURAL

DIPRO

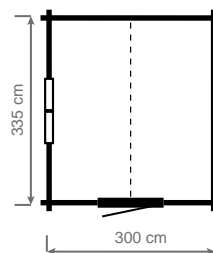

1 porte stable WPD,
1 fenêtre WRG + volets

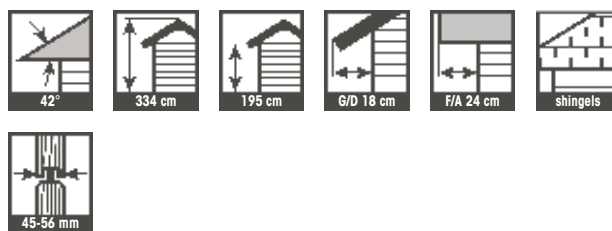

TINGA

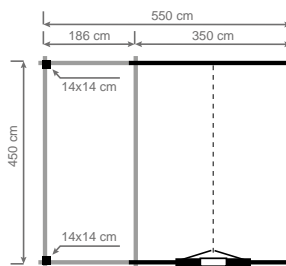

1 porte double ½ verre et
1 fenêtre WRG avec volets
+ 1 fenêtre ovale VRO

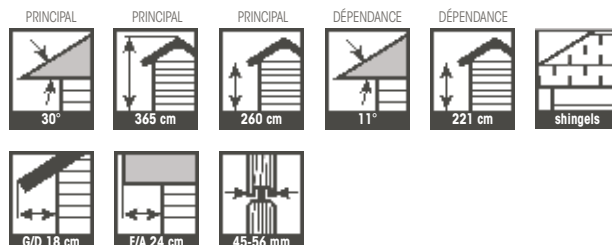

FUKONYS

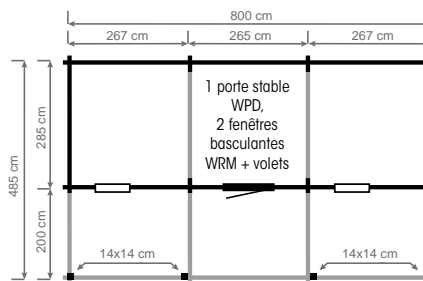

1 porte stable
WPD,
2 fenêtres
basculantes
WRM + volets

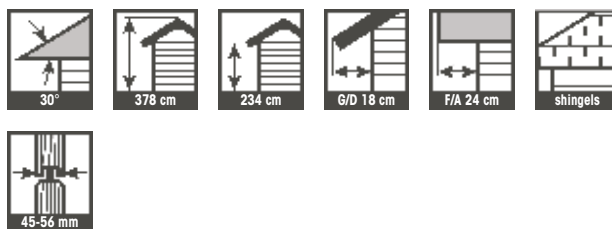



PILOSA

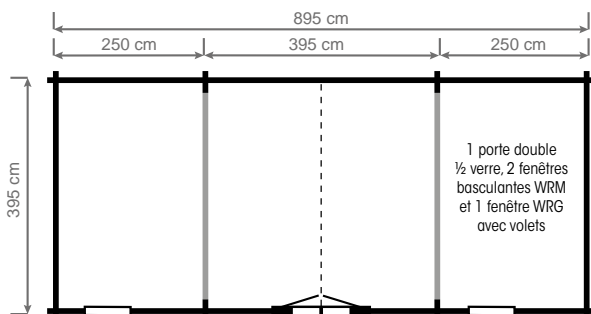

PRINCIPAL	PRINCIPAL	PRINCIPAL	DÉPENDANCE	DÉPENDANCE				
30°	443 cm	325 cm	15°	208 cm	shingels	G/D 24 cm	F/A 18 cm	45-56 mm

STYLE RURAL



PROCO

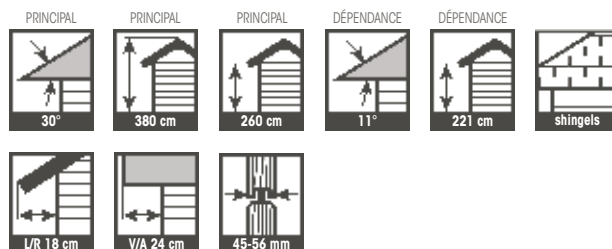
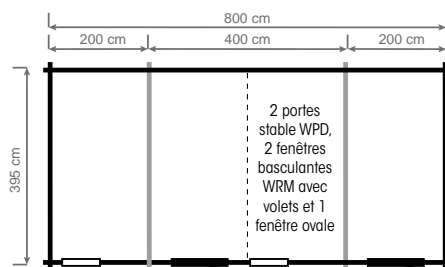

CREDONA

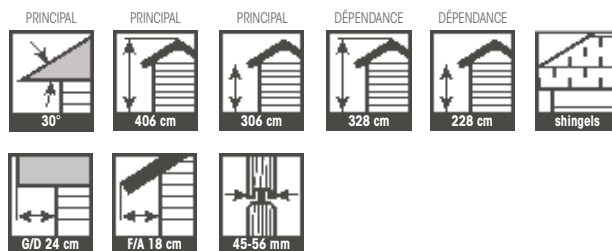
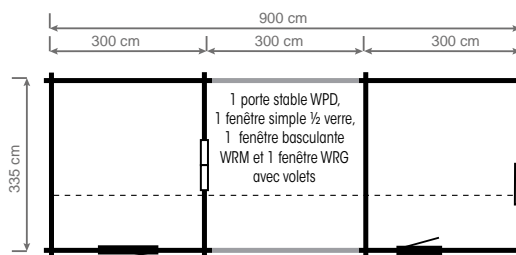

HARAMI

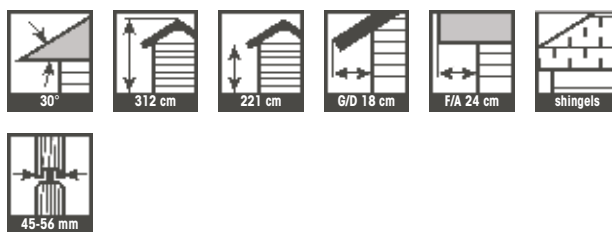
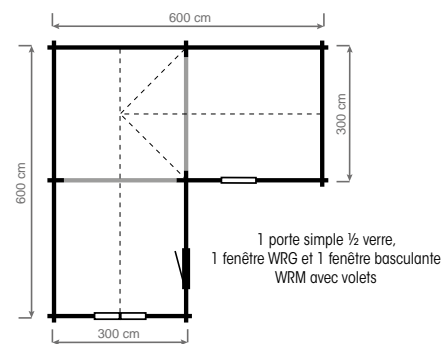



PRODUITS DE CHEZ NOUS



CERTIFICAT D'AUTHENTICITE



Par ce certificat on déclare que la construction Grandcasa, objet du bon de commande....., est une production authentique originaire du site de production à Elversele, Belgique, et également produit selon la norme de qualité Force Plus pour les profils en coupe-vent.

Ce certificat garantit également que la construction mentionnée ci-dessus est construite avec du bois qualitatif-pin, originaire du Nord de l'Europe, livrée conforme à la norme NEN(5466) avec le certificat KOMO correspondant et certifiée PEFC (CoC N° CTIB-TCHN 0938).

Elversele - Belgique, 2025



Emis par:
Pontweg 9C - 9140 Elversele - Belgique



CERTIFICAT D'AUTHENTICITÉ = certificat d'origine

Un certificat d'authenticité est en réalité un certificat d'origine. De cette manière, nous vous garantissons que votre chalet Grandcasa est un produit d'origine qui provient de nos manufactures et a été produit dans les pays du Benelux selon le principe des profilés de chalet coupe-vent, notre label de qualité Force Plus.

Ce label de qualité garantit également l'origine et la qualité du bois. Les chalets de la marque Grandcasa sont aussi certifiés PEFC.

Le certificat d'origine de nos chalets vous garantit que votre chalet a été produit en suivant un processus de production de qualité conforme aux normes occidentales avec du bois de qualité, cultivé dans le respect de l'environnement. Nous avons développé ce certificat d'authenticité parce qu'il existe sur le marché des produits bien meilleur marché, mais de qualité moindre, fabriqués en Europe centrale et/ou de l'Est selon un processus de fabrication douteuse et avec du bois de moins bonne qualité. Souvent, la vraie qualité du produit est passée sous silence, mais le client apprend tôt ou tard les conséquences désastreuses de son choix. Nous vous conseillons donc d'acheter un chalet avec un certificat d'origine. Au final, vous ferez des économies. Méfiez-vous des copies bon marché provenant d'Europe de l'Est.

DEMANDEZ TOUJOURS VOTRE CERTIFICAT D'AUTHENTICITÉ! Faites attention aux constructions inférieures de l'Europe de l'Est

SERVICE ET GARANTIE

Notre service après-vente français est disponible 5 jours sur 7, du matin au soir. Nos services de production et service après-vente réservés à nos professionnels se situent en Belgique, à proximité de nos clients.

PROFIL IMPERMÉABLE AU VENT DU BOIS DE QUALITÉ

- Double fraisage
- Les plus grandes rainures et languettes du marché. 15 mm assure une plus grande robustesse



Les chalets Grandcasa sont fabriqués avec du pin de qualité provenant d'Europe du Nord, selon les normes NEN 5466, et ils sont livrés avec un certificat KOMO. Le froid fait pousser ces arbres plus lentement, ce qui rend le bois plus solide et permet de garantir une durée de vie bien plus longue à nos chalets.



TEINTES ET ENTRETIEN EN OPTION



SUPER PRIMER 5 L Insecticide - Fongicide - intérieur et extérieur



- Produit de protection du bois incolore et à forte pénétration.
- Action préventive et curative.
- Idéal comme couche d'apprêt.
- Insecticide, fongicide et anti-bleu
- Sans odeur tenace.
- Convient pour l'intérieur et l'extérieur.
- Sarpeco Aqua Multi (10806B).
- Utiliser cette préservation du bois en toute sécurité.
- 10 m²/Litre en 1 couche.
- Attendre par beau temps sec au minimum :
2 à 3 semaines après le montage avant toute application :
1 semaine pour couvrir par un autre produit l'extérieur
et 2 semaines après avoir traité l'extérieur par Super Primer pour appliquer le Super Primer en intérieur
- Nous déconseillons vivement de couvrir l'intérieur par tout autre traitement.



SUPER PROTECT 5 L

- Produit de protection qui teinte le bois sans cacher les veines.
- Protection contre les intempéries et le bleuissement.
- Hydrofuge, protège contre les rayons U.V...
- Peu odorant, ne s'écaille pas.
- Uniquement pour l'extérieur
- 5 m²/Litre en 2 couches : attendre au minimum 24 h par beau temps sec entre les 2 couches.



	1	Chêne clair	RAL0200
	2	Chêne	RAL0101
	3	Chataigne	RAL0300
	4	Chêne foncé	RAL0103
	5	Blanc opale	RAL9001
	6	Gris clair	RAL0005
	7	Gris pierre	RAL7030
	8	Gris beige	RAL1019
	9	Vert salé	RAL0039
	10	Brun noir	RAL8022

Dans tous les cas, ASR vous recommande de consulter un spécialiste au sujet des traitements adaptés aux résineux.

Il vous faut suivre dans tous les cas : les instructions du fabricant des produits utilisés.

ASR ne présente aucune garantie sur tous les traitements utilisés, même si fournis par ASR :
sous la stricte et seule responsabilité du Client.



TEINTES ET ENTRETIEN EN OPTION



VIKING - 2,5L

- Enduit couvrant (68 % de matières solides)
- Résines alkydes avec de l'huile de lin
- RÉGULATEUR D'HUMIDITÉ et HYDROFUGE
- Résistant aux UV
- Élastique et EXTRÊMEMENT DURABLE
- Uniquement pour l'extérieur
- 5 m²/Litre en 2 couches : attendre au minimum 24 h par beau temps sec entre les 2 couches.



INDUSTRIAL



TERRA

RAL9005

Noir

RAL7016

Gris anthracite

RAL8019

Gris brun

RAL7032

Camel beige

RAL7044

Gris soie

RAL7036

Gris platine

RAL1019

Brun sable

RAL9001

Blanc crème

RAL7030

Gris pierre

RAL5008

Gris bleu

RAL7006

Argile

RAL9002

Gris blanc

AMAZONE



MARINE

RAL6005

Vert mousse

RAL7002

Gris olive

RAL5014

Bleu Danube

RAL5001

Bleu-vert

RAL6011

Olive

RAL6028

Vert pin

RAL 5023

Bleu royal

RAL5008

Gris bleu

RAL1008

Vert olive

RAL5024

Bleu pastel

Dans tous les cas, ASR vous recommande de consulter un spécialiste au sujet des traitements adaptés aux résineux.

Il vous faut suivre dans tous les cas : les instructions du fabricant des produits utilisés.

ASR ne présente aucune garantie sur tous les traitements utilisés, même si fournis par ASR :
sous la stricte et seule responsabilité du Client.

ELEGANCE





ELEGANCE

Grâce à nos vitres coulissantes, vous créez en un tour de main un chalet de jardin, dont vous pourrez profiter toute l'année dans votre jardin ou sur votre terrasse.

Les panneaux de verre ne sont pas ceints d'un cadre, ce qui vous offre une vue complètement dégagée. En bref, vous vous sentez plus proche de la nature.

AVANTAGES

- Un toit plat, un toit royal ou un toit cottage
- L'épaisseur du bois est de 33, 45 et 56 mm
- De robustes poteaux de soutien de 14 x 14 cm
- Toiture : EPDM avec finition en aluminium ou shingles (tuiles en bois) disponible en quatre couleurs
- Vitres de 10 mm d'épaisseur en verre de sécurité
- En option : terrasse avec revêtement anti-dérapant 28 x 145 mm



OPTION: Puit de lumière 80 x 200 cm en verre de sécurité en polycarbonate trempé, haute résolution du bruit (-39 db)



ELEGANCE

BAJA

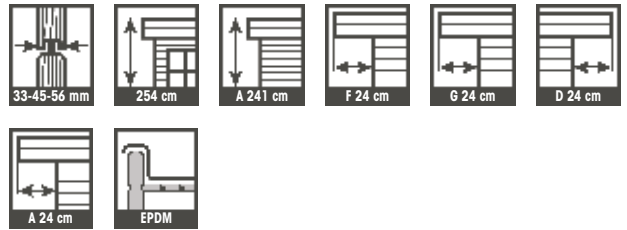
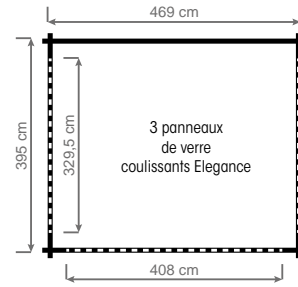

TATA

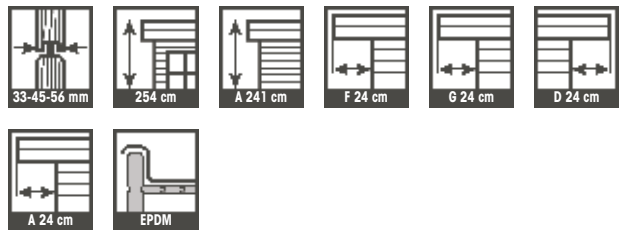
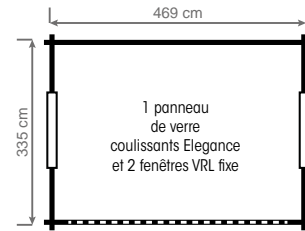

SIFY

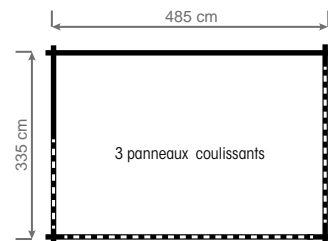



SILKO

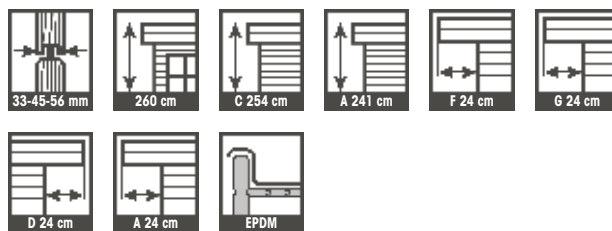
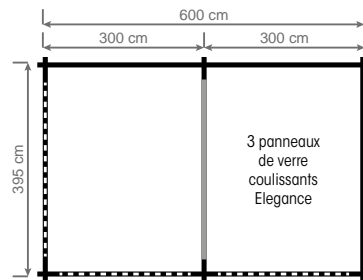

FARO

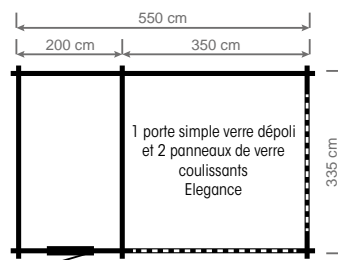

SINTRA

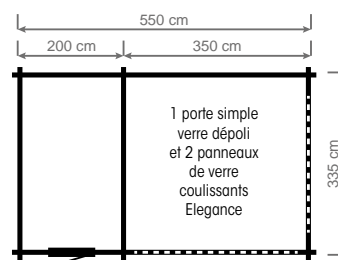

MORIENTES

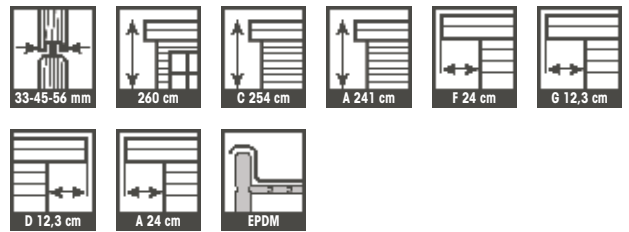
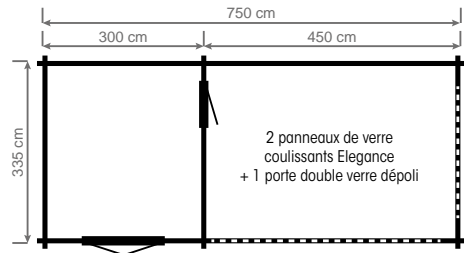

ESTORIL

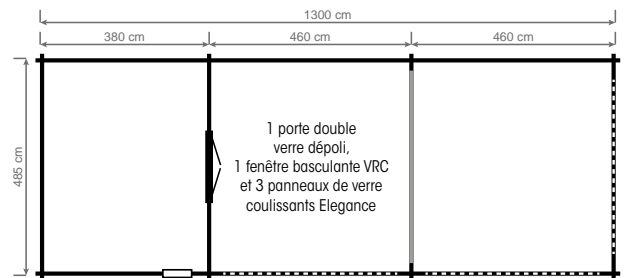

BENSON

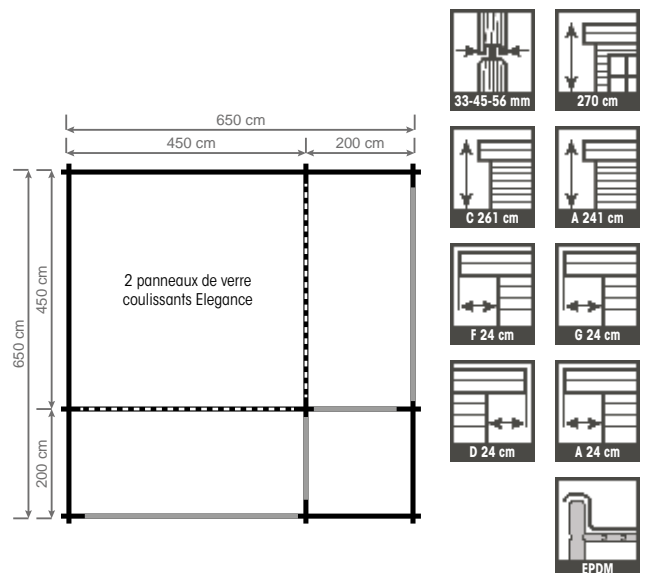



MILLET

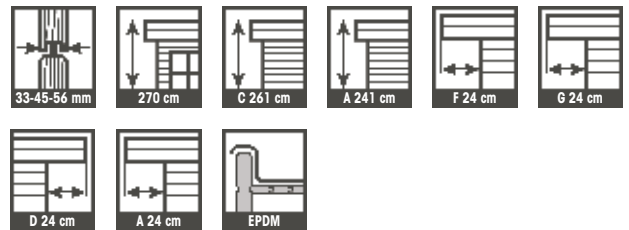
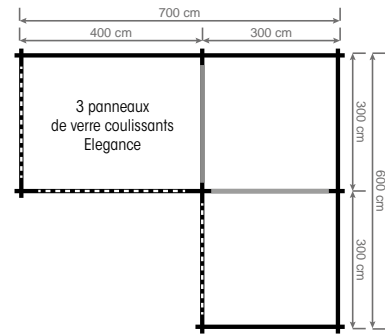

SOPRON

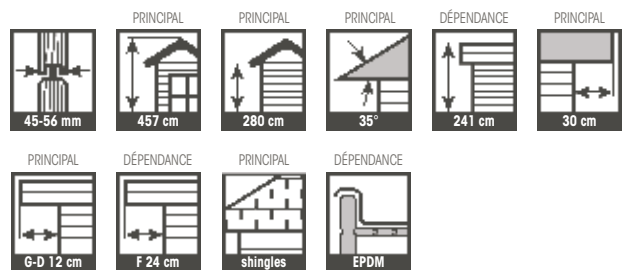
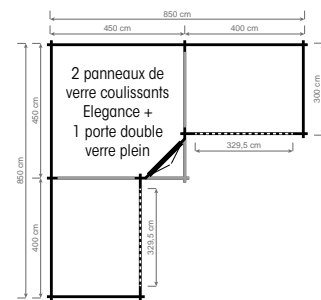

LAUTREC

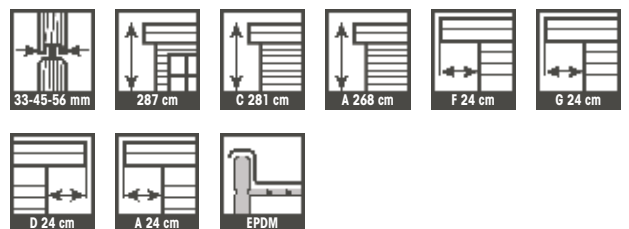
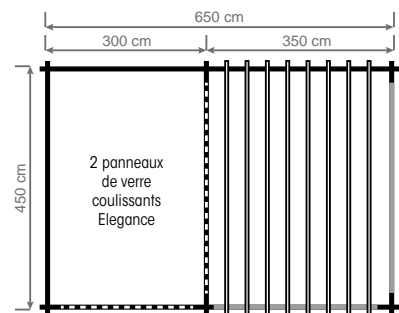

ELEGANCE

ELEGANCE

DABAS

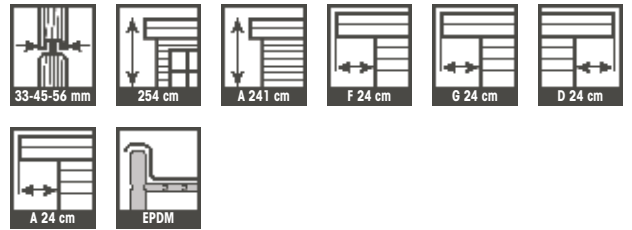
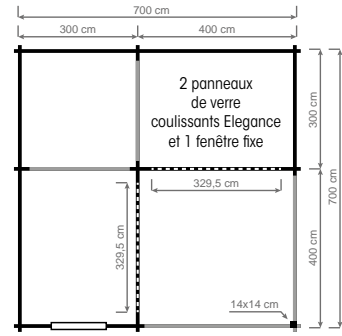

BALKANY

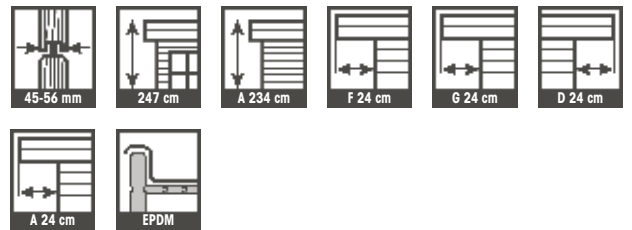
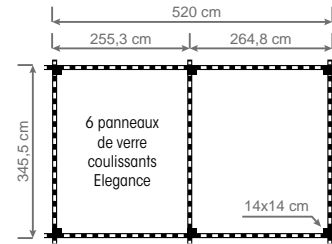

TIHANY

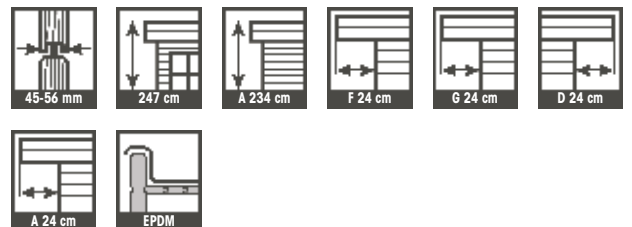
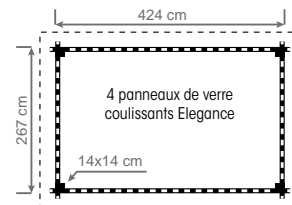



GALLE

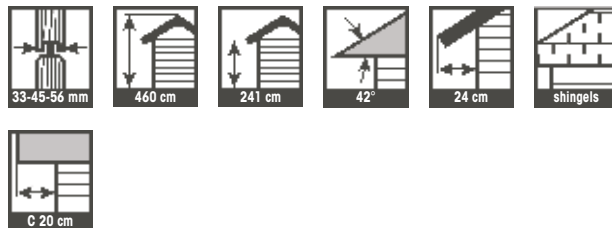
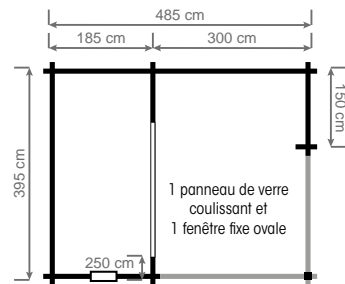

LAVOIR

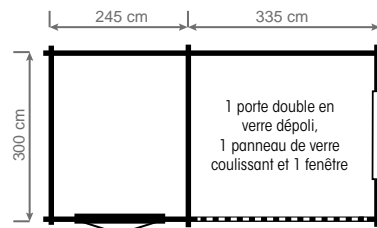

WOTUBA

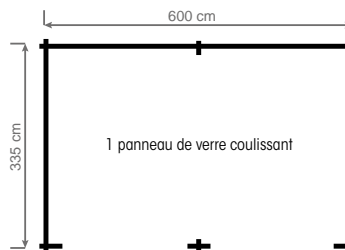

ELEGANCE

ANGELO

set de gouttières en option

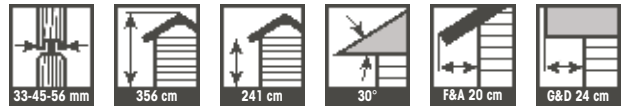
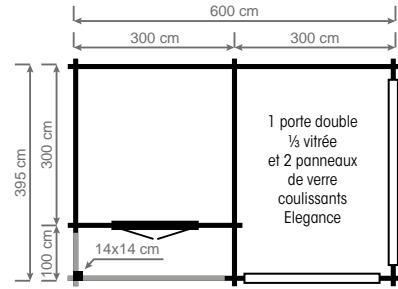

DELVAUX

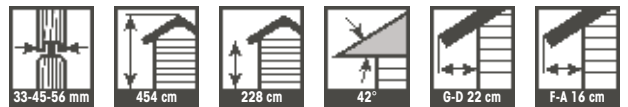
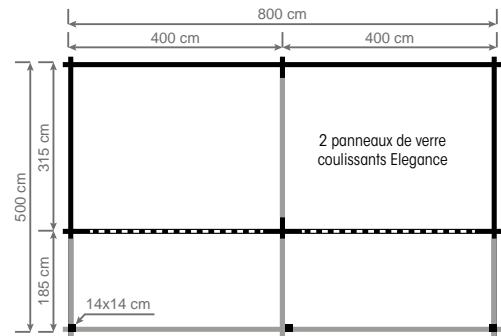

BOLDINI

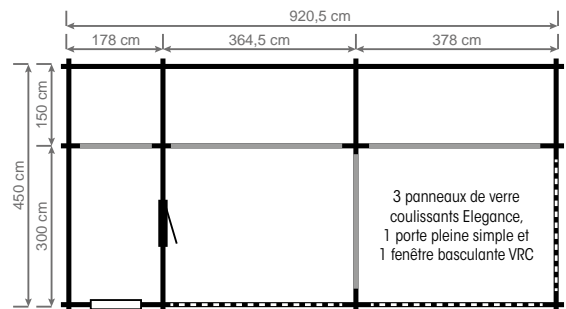



ESTEMOZ

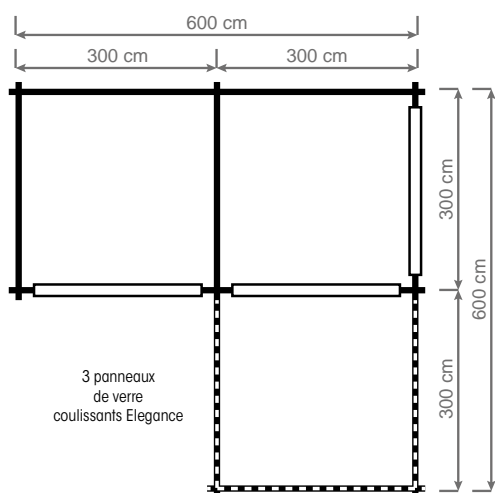

ELEGANCE

MORONI

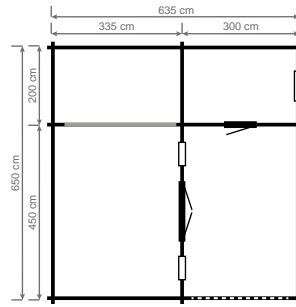

1 porte double ¾ vitrée, 1 porte simple pleine, 1 panneau de verre ES5 et ES3, 1 fenêtre basculante VRC et 5 fenêtres fixes VRL

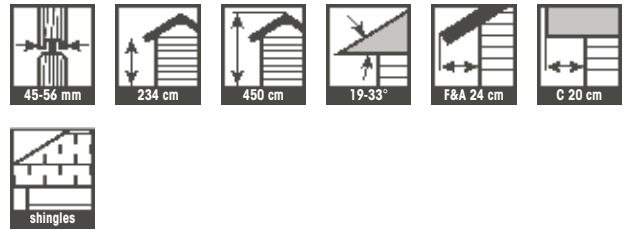

PAULI

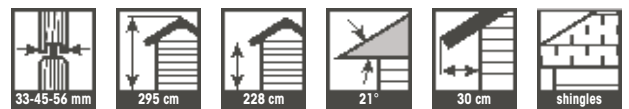
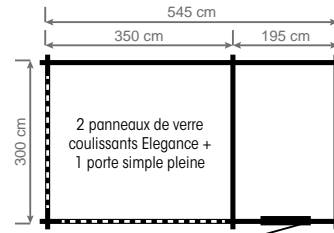

PINCHON

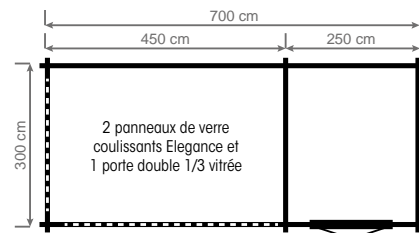



PICABIA

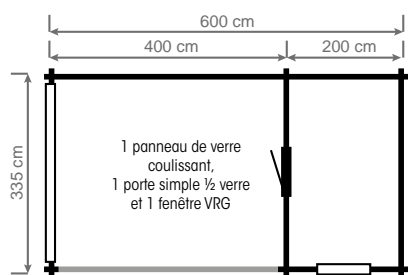

ELEGANCE

145

ELEGANCE

TOKI

set gouttières en option

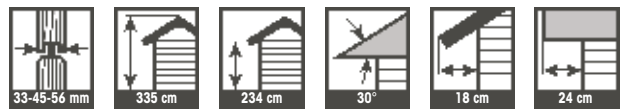
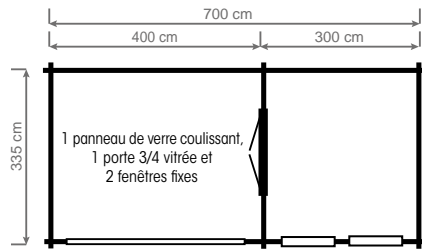

KIMI

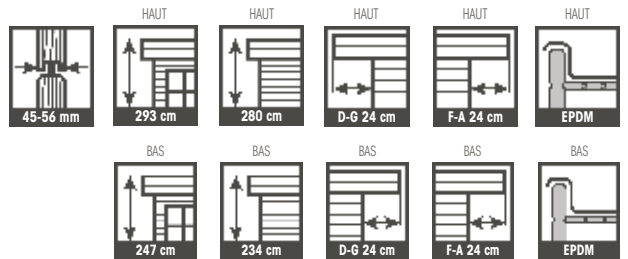
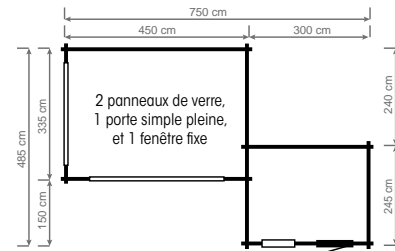

SADO

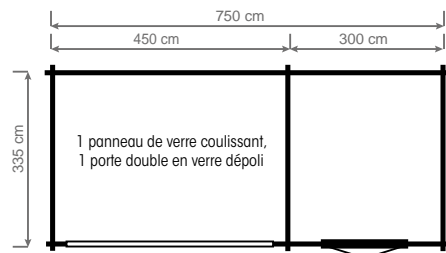

PANNEAUX DE VERRE



PANNEAUX DE VERRE



1 Des panneaux de verre de 82 cm avec une épaisseur de 10 mm en verre de sécurité trempé et poli

2 Les panneaux de verre glissent sur 2, 3, 4 ou 5 rails

3 Un cadre en aluminium (hauteur : 2 m) en couleur anthracite (RAL 7024) ou blanc crème (RAL 9001)

4 Des poignées qui permettent de faire coulisser les panneaux automatiquement

5 Serrure à cylindre - EN OPTION: serrure à cylindre en métal anodisé avec pêne

6 Bas de porte, protection optimale contre le vent

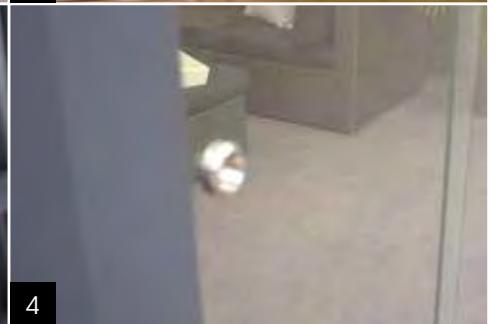
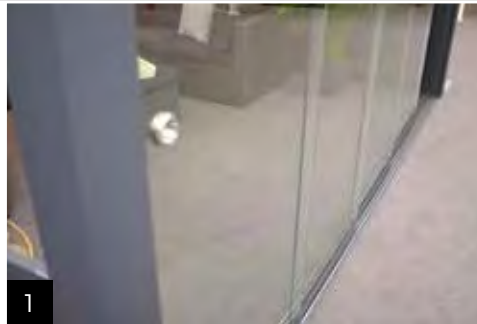

BUREAUX DE JARDIN





BUREAUX DE JARDIN

Nos bureaux de jardin contemporains en bois vous permettront de travailler à domicile en toute quiétude en maintenant une séparation entre vos activités professionnelles et votre vie privée. Nos bureaux de jardin sont équipés de châssis de fenêtres et de portes en aluminium, elles-mêmes pourvues d'un vitrage isolant. Ils permettent ainsi de créer chez vous un lieu de travail chaleureux qui maintiendra votre productivité.

ALUMINIUM fenêtres/portes

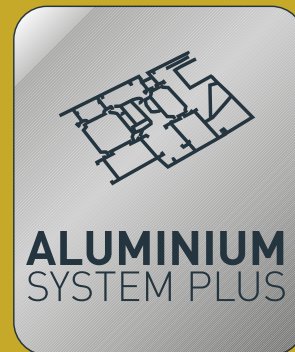

AVANTAGES

- Plusieurs formes de toit possibles
- Épaisseur du bois 45 et 56 mm
- Fenêtres et portes en aluminium de haute qualité
- Pourvues d'un vitrage isolant
- Toiture : EPDM avec finitions en aluminium ou bardeaux disponibles en quatre couleurs

BUREAUX DE JARDIN

BEC

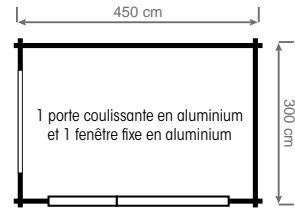

DECANIS

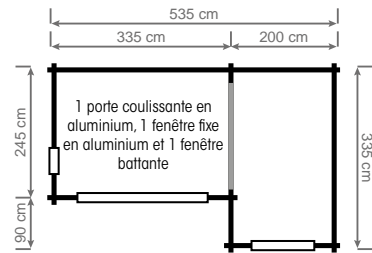

TRABENDO

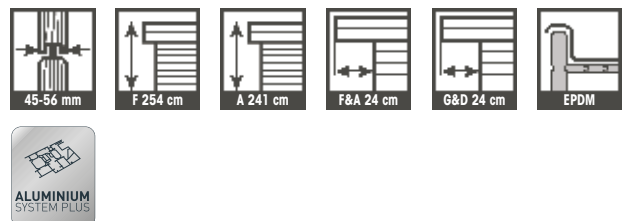
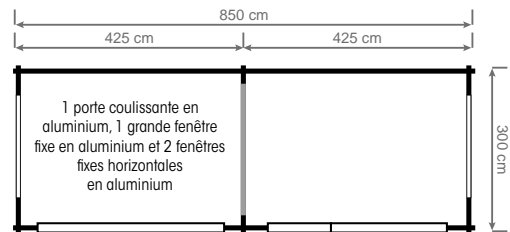



MANTECA

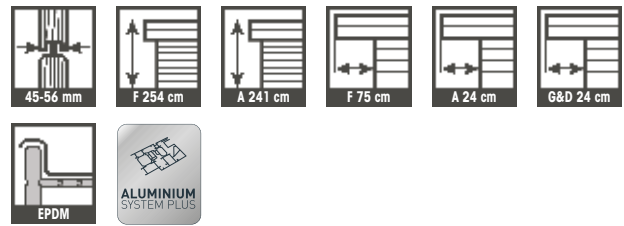
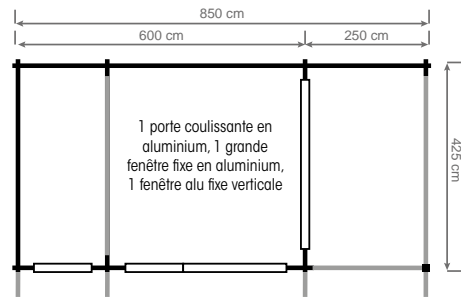

KENZO

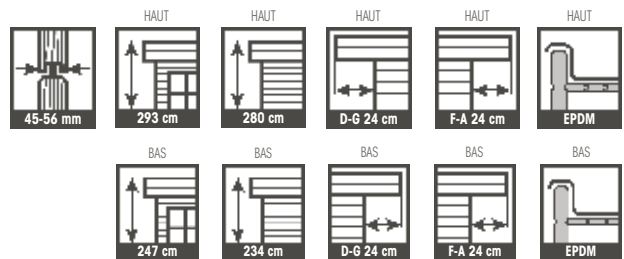
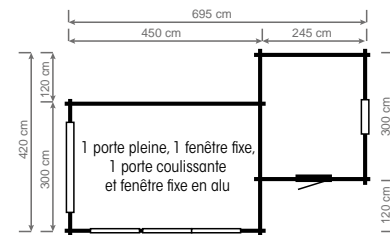

MALO

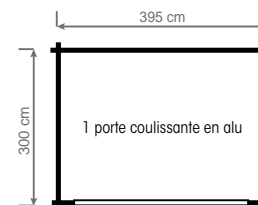

BUREAUX DE JARDIN

BLOMET

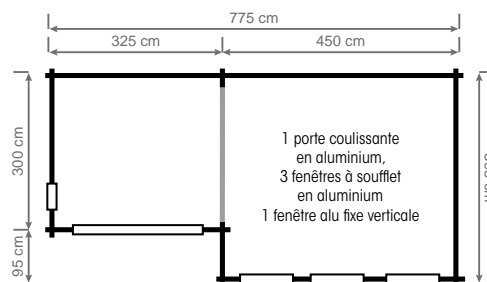

BARAKI

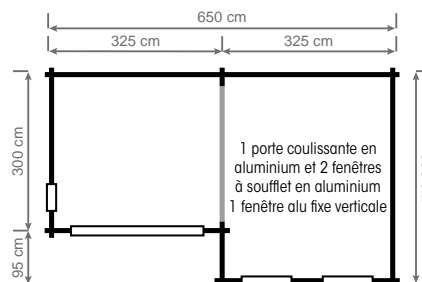

CALI

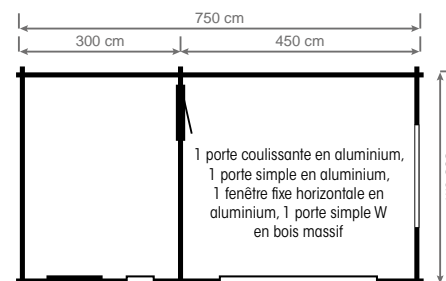



CHARONNE

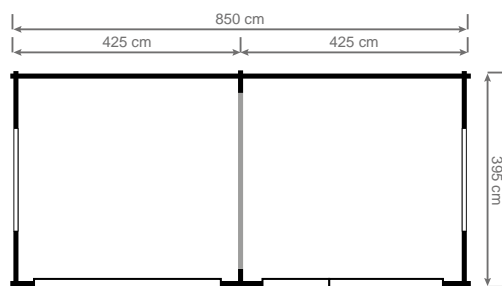

1 porte coulissante en aluminium, 1 grande fenêtre fixe en aluminium,
2 fenêtres fixes horizontales en aluminium



45-56 mm



234 cm



352 cm



30°



G&D 24 cm



F&A 18 cm



shingels



ALUMINIUM
SYSTEM PLUS

INTÉRIEUR

Nos portes intérieures, parois, poutres de toit et planchers en bois massif créent un confort scandinave authentique.

Les abris de jardin en bois de Grandcasa offrent une ambiance confortable à votre intérieur.





CHALETS DE LOISIRS





CHALETS DE LOISIRS

Les abris de jardin de Grandcasa conviennent aussi très bien comme abris de vacances ou résidences d'été.

La mer, la montagne, une île exotique : nos abris de jardin s'intègrent à tous les environnements.

Bien entendu, les chalets de vacances peuvent toujours être livrés sur mesure.

Grandcasa est en effet le grand spécialiste du travail personnalisé.

AVANTAGES

Concevez vous-même votre chalet en choisissant parmi nos nombreuses options de base.

- Isolation de toiture et de plancher
- Planchers en bois, planchers de terrasses et balustrades
- Planchers de logement, élévations, parois intérieures
- Le plus grand choix de toitures
- 3 types de fenêtres et portes, double vitrage
- Gouttières : pvc ou métal galvanisé
- Escalier intérieur en bois

CHALETS DE LOISIRS

MONACO

panneaux de tuiles en option

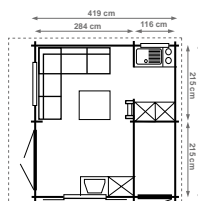

MONACO 17 m²

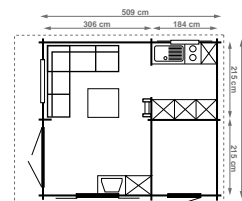

MONACO 21 m²

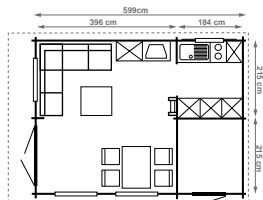

MONACO 25 m²

Portes et Fenêtres :
Ligne Confort : 1 porte double, ¼ vitrée,
1 porte pleine, 1 fenêtre VRM et 2 VRG
Monaco 25 m² : 1 fenêtre VRG en plus

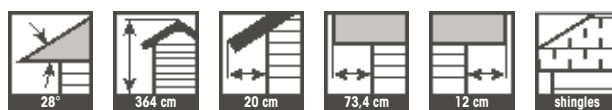
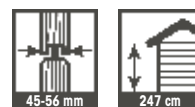

ANDORRA

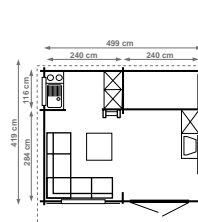

ANDORRA 20 m²

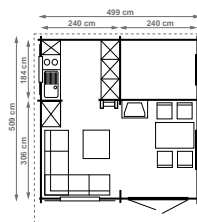

ANDORRA 24 m²

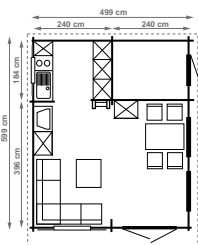

ANDORRA 28 m²



Portes et Fenêtres :
Ligne Confort : 1 porte double, ¼ vitrée,
1 porte pleine, 1 fenêtre VRM et 2 VRG
Andorra 28 m² : 1 fenêtre VRG en plus

DOMINICA

panneaux de tuiles en option

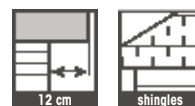
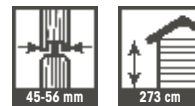
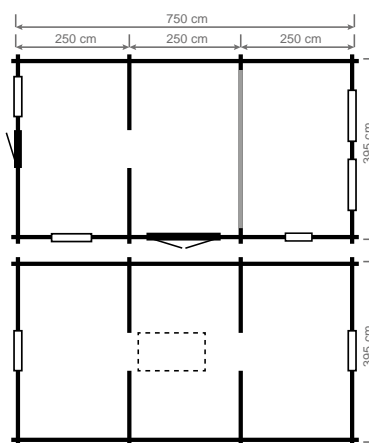

1 porte simple ½ vitrée, 1 porte double ¼ vitrée,
4 fenêtres VRC et 2 VRG + étage



MONZA

set de gouttières et panneaux de tuiles en option

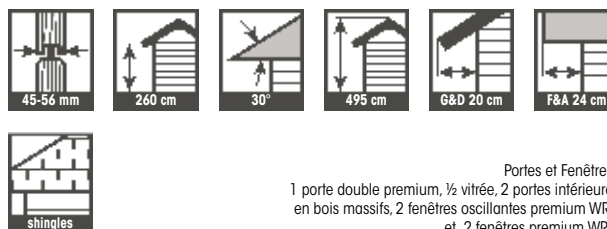
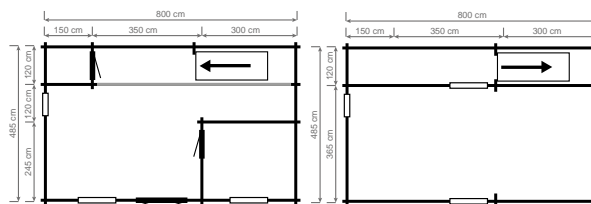

Portes et Fenêtres :
1 porte double premium, 1/2 vitrée, 2 portes intérieures
en bois massifs, 2 fenêtres oscillantes premium WRG
et 2 fenêtres premium WRM

MOUSTIQUE

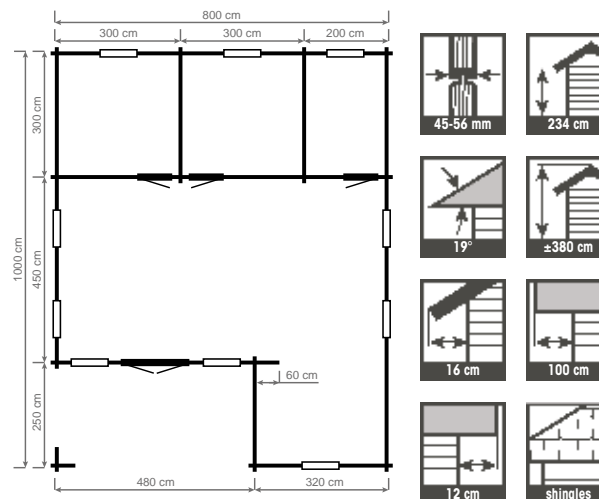

- Toit en auvent : 480 x 250 cm
- 1 porte double, 1/4 vitrée, 9 fenêtres VRG, 1 VRK et 3 portes intérieures

SABA

portes et fenêtres exclusives et set de gouttières en option

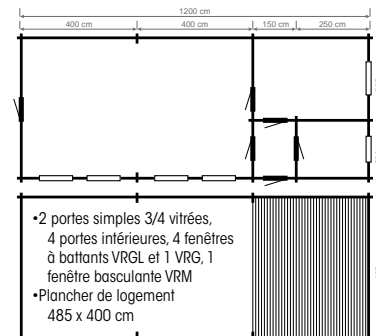

- 2 portes simples 3/4 vitrées, 4 portes intérieures, 4 fenêtres à battants VRGL et 1 VRG, 1 fenêtre basculante VRM
- Plancher de logement 485 x 400 cm

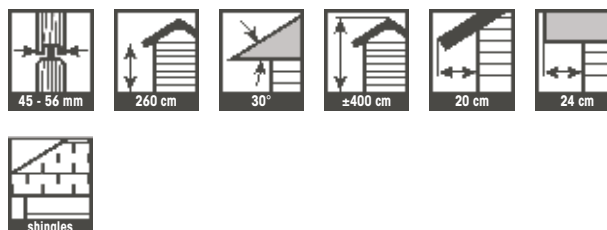

CHALETS DE LOISIRS

MADINA

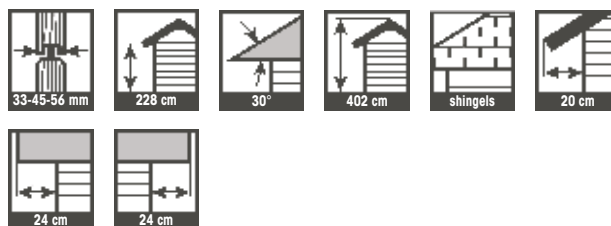
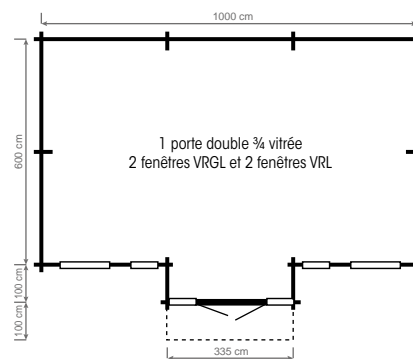

MAGRITTE

portes et fenêtres en bois dur en option

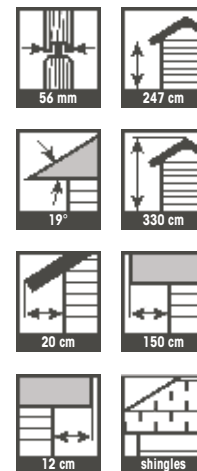
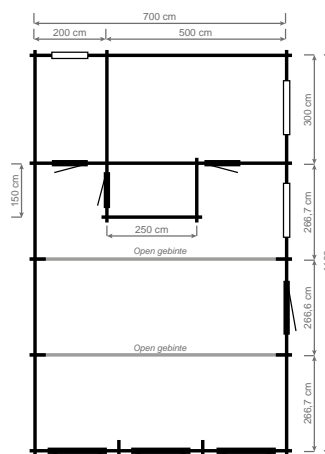

- 3 portes doubles 3/4 vitrée, 1 porte simple 1/2 vitrée, 3 portes intérieures, 4 fenêtres VRG à deux ouvrants et 1 fenêtre VRC basculante

GRACIOZA

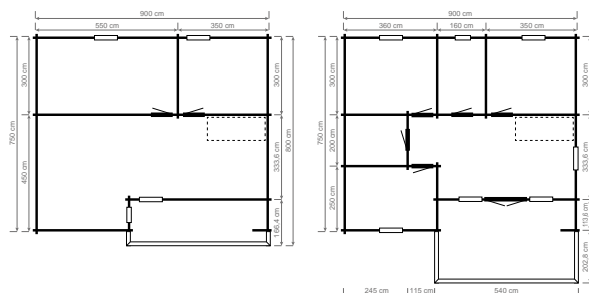

- Vide : ± 12 m², terrasse ± 16 m² avec plancher, balcon ± 8.5 m²
- Toit en auvent : 550 x 100 cm avec plancher de terrasse
- Division intérieure selon plan
- 1 porte double 3/4 vitrée, 1 porte simple VDE34, 5 fenêtres VRG, 2 VRM, 2 VRC, 2 VRLX, 1 VRGL et 7 portes intérieures

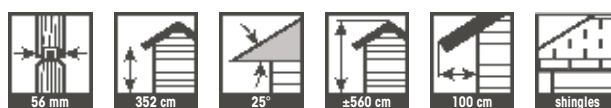



PICON

panneaux tuiles en option

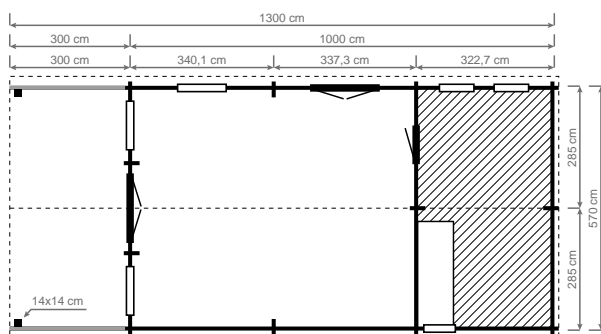

- 2 portes en verre premium, 1 porte intérieure en bois massif,
- 2 fenêtres premium WRM, 3 fenêtres premium WRGL et 2 fenêtres tabatières

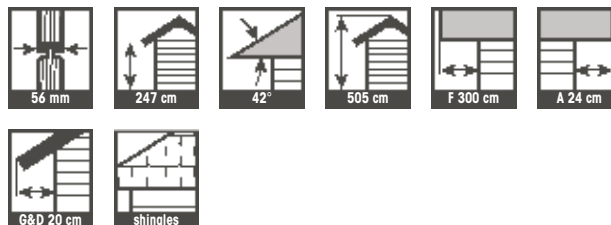

CHALETS DE LOISIRS

SIKLOS

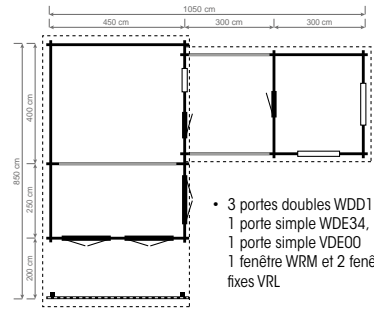

- 3 portes doubles WDD11,
- 1 porte simple WDE34,
- 1 porte simple VDE00
- 1 fenêtre WRM et 2 fenêtres fixes VRL

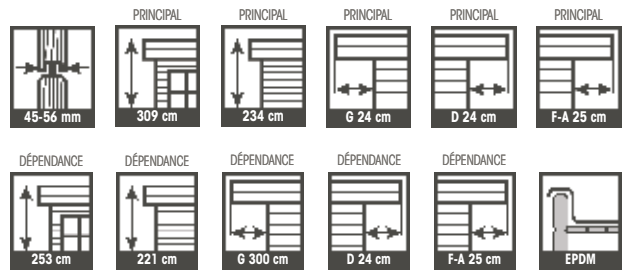

MIMAS TANGUY

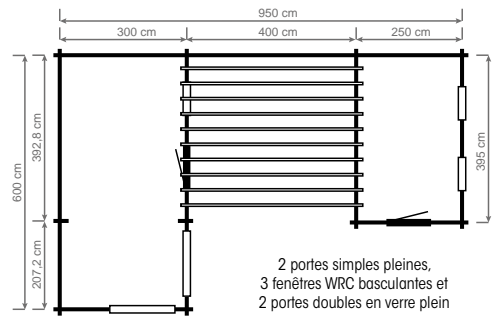

- 2 portes simples pleines,
- 3 fenêtres WRC basculantes et
- 2 portes doubles en verre plein



UFURI

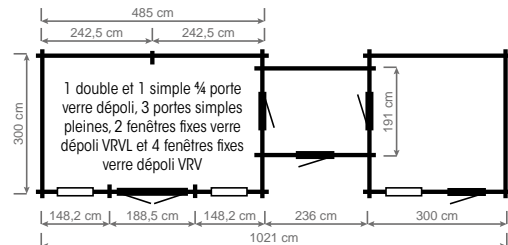

- 1 double et 1 simple ¼ porte
- verre dépoli, 3 portes simples
- pleines, 2 fenêtres fixes verre
- dépoli VRVL et 4 fenêtres fixes
- verre dépoli VRV

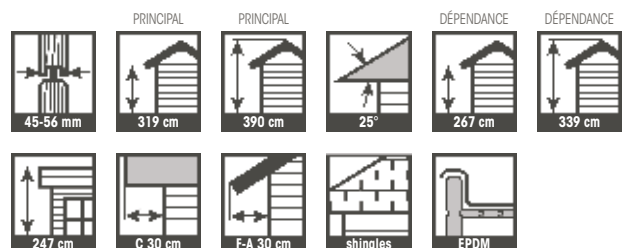



ALEGRANZA

toit en chaume en option

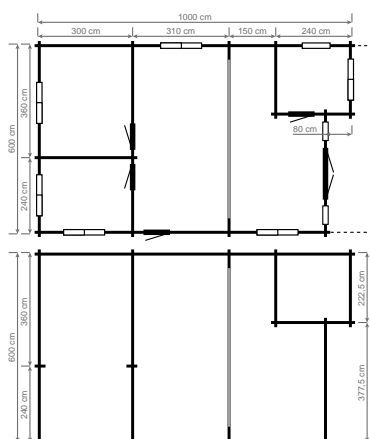

- 1 porte double $\frac{3}{4}$ vitrée, 3 portes intérieures, 6 fenêtres VRG à deux ouvrants, 3 fenêtres VRK basculantes et 1 fenêtre VRC basculante
- Plancher de logement 600 x 300 cm

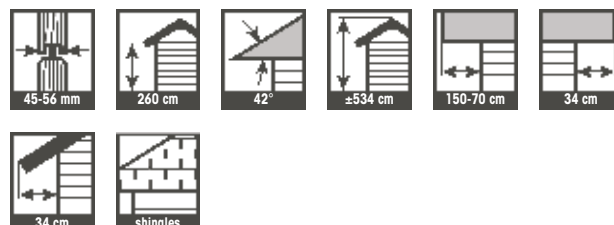

CHALET DE LOISIRS

KILAKU

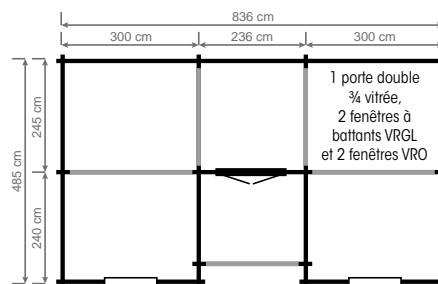

1 porte double
¾ vitrée,
2 fenêtres à
battants VRGL
et 2 fenêtres VRO

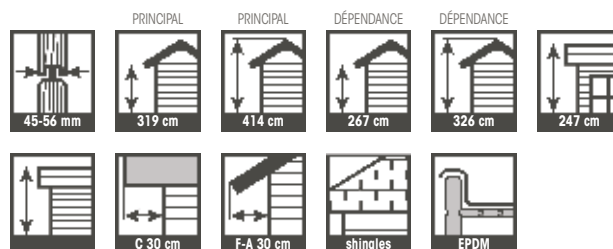

ZAMBEZI

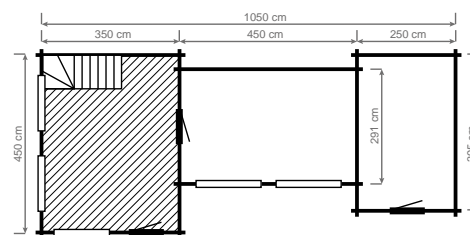

2 portes en verre plein doubles, 3 portes pleines et 3 fenêtres fix VRL

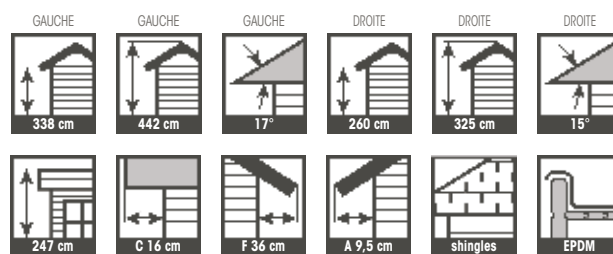

KURAMATHI

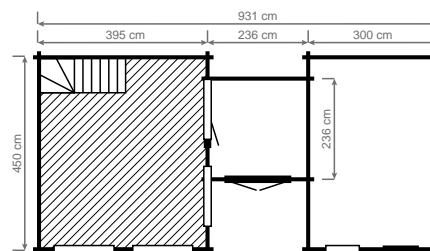

1 porte double ½ vitrée, 2 portes simples pleines,
4 fenêtres fixes VRL et 1 fenêtre basculante VRM

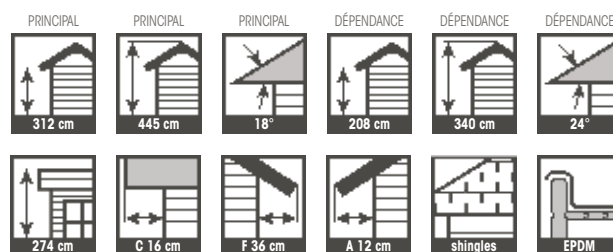



SONIRO

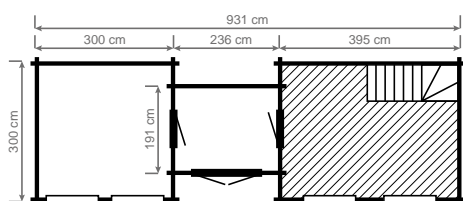

1 porte double ¾ vitrée, 2 portes simples pleines,
4 fenêtres à battants VRGL et 2 fenêtres fixes VRL

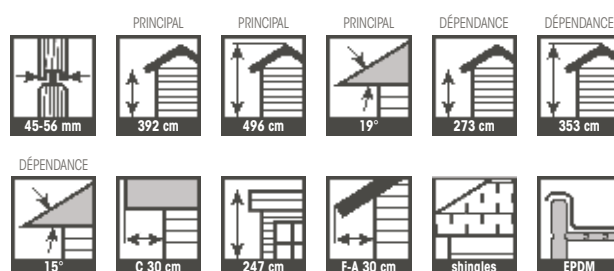



ISOLATION EN OPTION



ISOLATION DU TOIT

Isolation du toit 60 mm (au-dessus)

- Lattage toiture
- Barrière de vapeur (fermée)
- Isolation 60 mm
+ poutres 60 mm
- Panneaux OSB 15 mm
- Pare-vapeur (ouvert)
- Couverture du toit

Isolation du toit 150 mm (sous le toit)

- Lattage du toiture 19 mm (en plafond)
- Barrière de vapeur (fermée)
- Isolation 150 mm
+ solives de toit
- Pare-vapeur (ouvert)
- Couverture du toit



ISOLATION DE PLANCHER

- Barrière de vapeur (ouvert)
- Poutres de plancher 58 x 58 mm
- Isolation 60 mm
- Barrière de vapeur (fermée)
- Plancher 19 mm

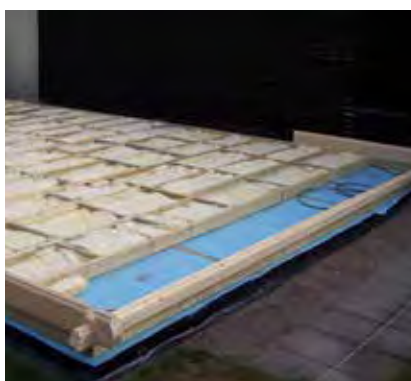



POUR LA GESTION DURABLE DES FORÊTS



GARAGES



La gamme de garages de Grandcasa est assez unique, même en Europe. Basé sur notre profil d'abri de jardin, nous avons développé un concept permettant d'enjamber de grands espaces, comme des garages, qui sont disponibles en plusieurs épaisseurs.



PORTE EN BOIS ROTATIVE (= STANDARD)

- Constituée de 2 battants
- Dimensions : 250 x 216 cm (E x H)
- Charnières lourdes et réglables galvanisées
- Latte de sol galvanisée en métal
- Habillée avec des planches de 16 mm
- Ferrures de porte en acier inoxydable

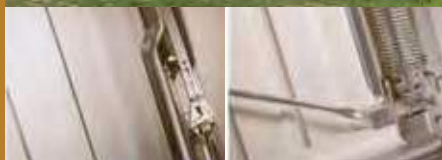

PORTE BASCULANTE

- Porte basculante blanche ou noire
- Dimensions : 237 x 200 cm
- Prévue d'une serrure à cylindre et une poignée synthétique
- Amortisseur pour une isolation acoustique optimale
- Disponibles en autres dimensions et couleurs RAL



PORTE SECTIONNELLE

- S'ouvre verticalement et permet une meilleure utilisation d'espace
- Dimensions = environ le passage entier
- isolation EPU à double paroi
- Finition Woodgrain
- Couleur blanche standard, autres couleurs RAL disponibles
- Plusieurs dimensions disponibles
- Automatisation et commande à distance disponibles

Nos garages sont disponibles en 3 exécutions : Classic, Colorado et Cosmos. Chacune d'entre elles peut bien entendu être réalisées en de nombreuses dimensions. Nous avons acquis une position unique sur le marché des garages doubles.

AVANTAGES

- Chaque construction présente au moins 1 chevron intermédiaire avec poutres de renforcement. Au moins 2 chevrons et renforcements, en fonction de la profondeur
- Epaisseurs de bois possibles : 33, 45 ou 56 mm
- 3 types de portes : Porte basculante en métal, porte sectionnelle ou porte en bois rotative (= standard)
- Fenêtres/portes et cloisons intérieures à ajouter selon vos désirs

GARAGES



Façade:	1 - 10 m
Profondeur:	1 - 30 m
Hauteur de faîte:	Classic de 2,76 jusqu'au 3,28 m
Pignons ouverts intermédiaires:	< 7m : 1 pignon ; > 7 m : 2 pignons
Fenêtres et portes:	Tous les fenêtres et portes sont possibles !



OPTION: portes sectionnelles en couleurs RAL





CLASSIC GARAGES



COSMOS GARAGES



OPTION: portes sectionnelles sur mesure



Configurations possibles



GARAGES

BUDA

set de gouttières en option

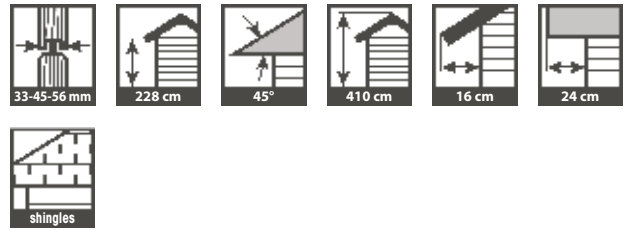
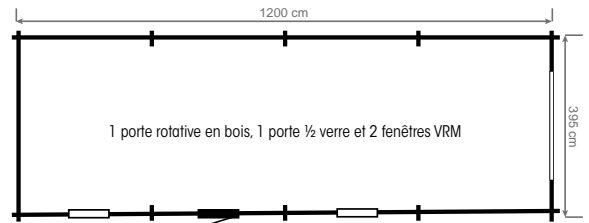

FLORENCE

set de gouttières en option

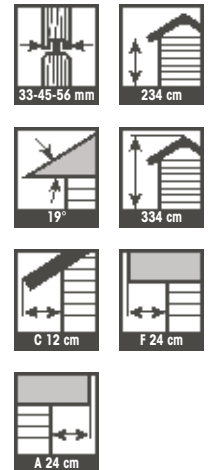
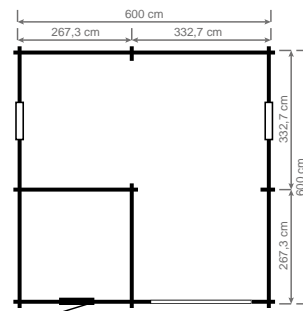

TOBAGO

portes basculantes en option

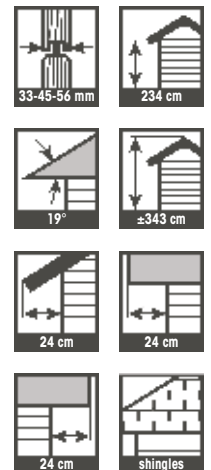
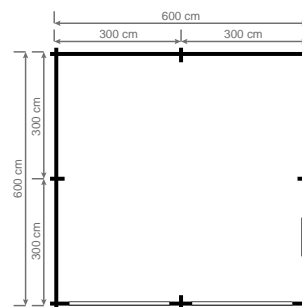







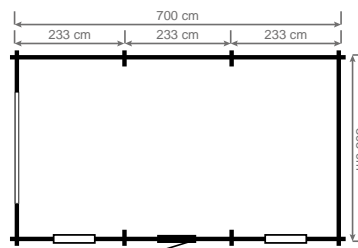

Equipé de deux portes basculantes, une porte simple 1/2 vitrée et une fenêtre à battants VRG



ZAPATO

set de gouttières en option







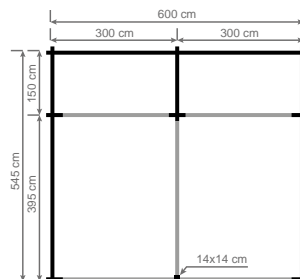

 33-45-56 mm	 221 cm	 42°	 ±401 cm	 16 cm	 24 cm
 24 cm	 shingles				

- Equipé d'une porte PO (deux battants),
- Une porte simple ½ vitrée, 2 fenêtres battantes et une fenêtre basculante

CORNWALLIS







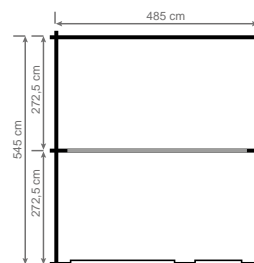

 33-45-56 mm	 C 228 cm
 42°	 ±403 cm
 20 cm	 24 cm
 shingles	

GRANADA

portes basculantes en option



 33-45-56 mm	 247 cm
 243 cm	 F&A 24 cm
 C 24 cm	 EPDM

Equipé d'une porte (deux battants) et une fenêtre battante

GARAGES

PULSIANO

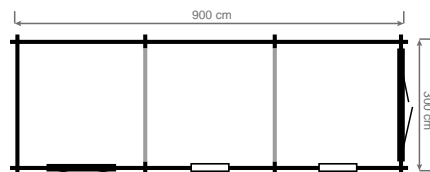

1 porte rotative, 1 porte double ½ verre et 2 fenêtres basculantes VRI



MONTEGO

porte basculante et set de gouttières en option

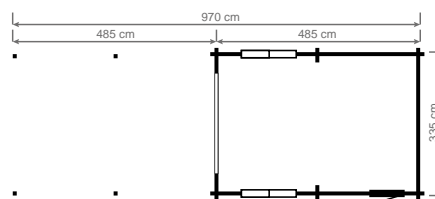

- Equipé d'une porte en bois à double battants, 1 porte simple, ½ vitrée et 2 fenêtres VRG fixées
- Poteaux de soutien: 14 x 14 cm

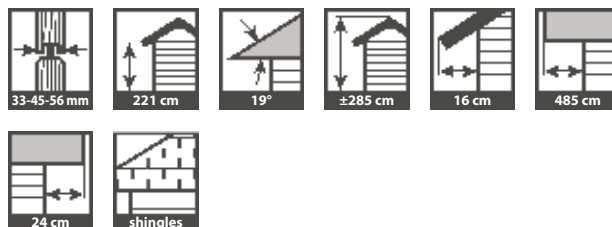

GERONA

panneaux de tuiles et volets en option

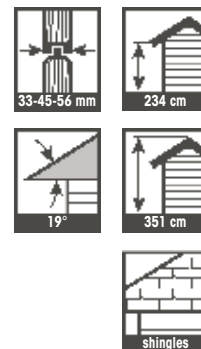
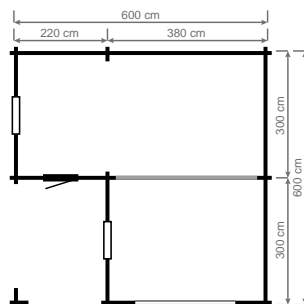

- Equipé d'une porte en bois à double battants, 2 fenêtres VRG et 1 porte simple, ½ vitrée
- Toit en auvent 220 x 300 cm avec plancher de terrasse



BECEDAS

porte sectionnelle en option

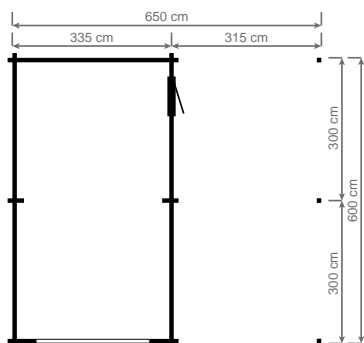

- Equipé d'une porte BPO (deux battants) et une porte simple pleine
- Auvent 600 x 338 cm

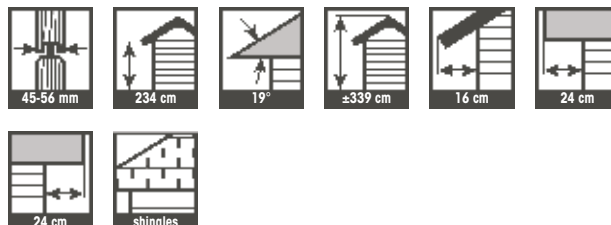

GARAGES

LOKONO

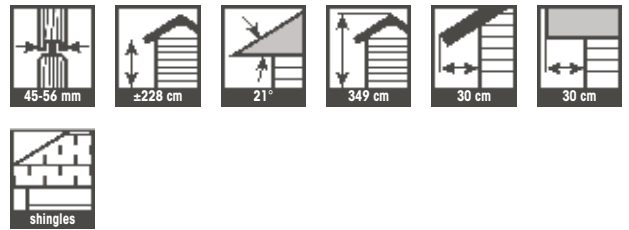
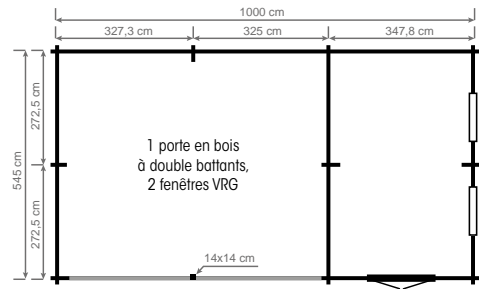

MABELIE

fenêtres et portes en option

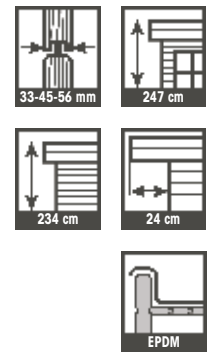
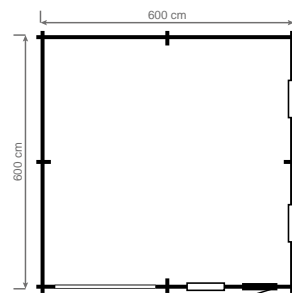

- 1 porte basculante métallique, 1 porte simple
1/2 vitrée, 1 fenêtre basculante VRM et 2
fenêtres à battants VRG



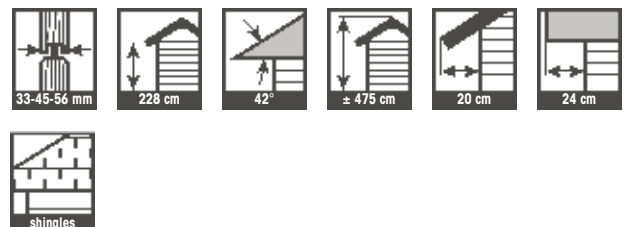
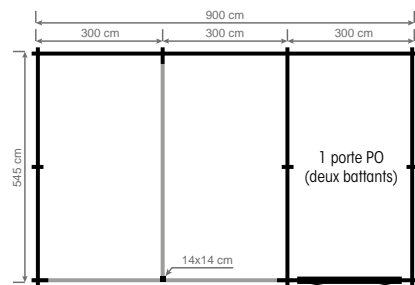



ORKNEY

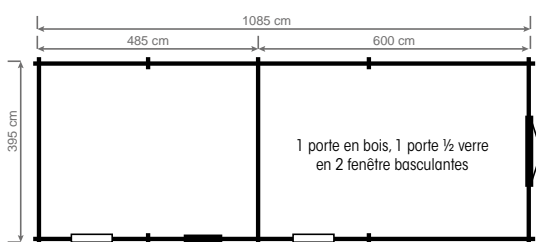



LESTER



 33-45-56 mm	 228 cm	 42°	 411 cm	 20 cm	 24 cm
 shingles					

TONNELLES

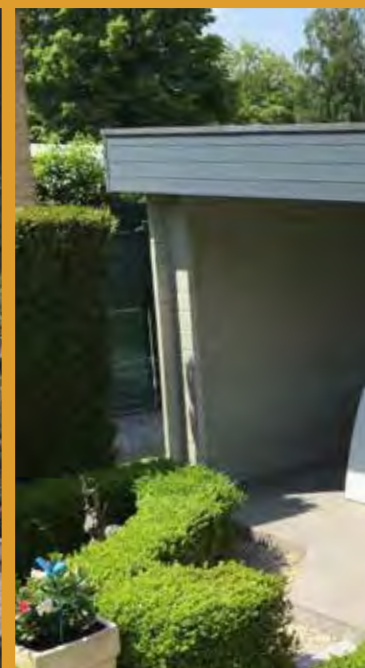

TONNELLES

178



TONNELLES

Des patios exceptionnels, spécialement conçus pour vous faire profiter pleinement de votre jardin.

Ces pavillons de luxe sont aussi des abris idéals pour un bain bulles ou un ensemble de meubles de jardin distingué.

AVANTAGES

- Un toit plat, un toit royal ou un toit cottage
- La hauteur de base des côtés est de 228 cm et l'épaisseur des murs est de 45 mm
- De robustes poteaux de soutien de 14x14 cm
- Toiture : EPDM avec finitions en aluminium ou shingles (4 couleurs)
- En option : terrasse avec revêtement anti-dérapant 28 x 145 mm
- Balustrades CROSS ou BARS (structures de 38 x 89 mm et poutres de 45 x 145 mm)

OPTION: balustrades



TONNELLES

ARUBA

set de gouttières et panneaux de jardin en option

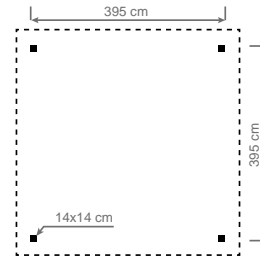

- Toit pyramidal avec sous-toiture en bois massif de 19 mm
- Poteaux de soutien robustes de 14 x 14 cm avec étaçons et solive



CUPID

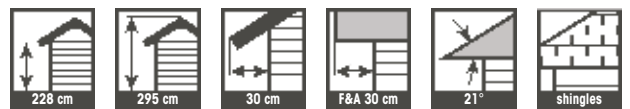
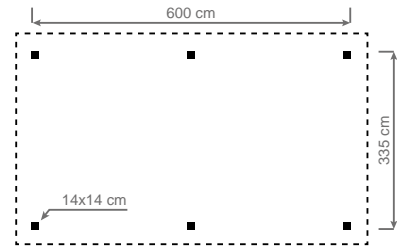

VENUS

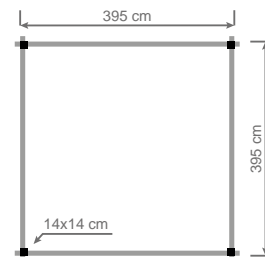



THOR

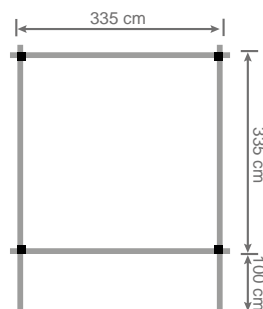

					
---	--	---	---	---	---

EROS

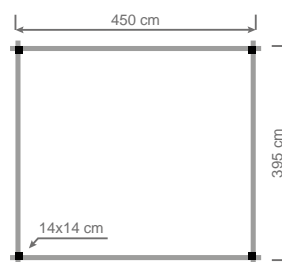

					
---	--	---	---	---	---

HEFI

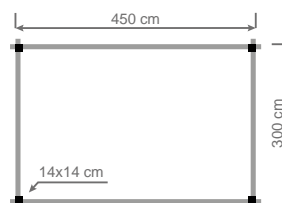

					
---	--	---	---	---	---

TONNELLES

DANZA

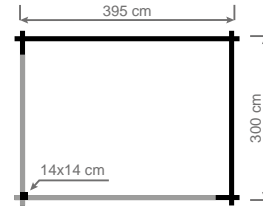

- Parois ouvertes, demi-ouvertes ou pleines : faites votre choix !
- Poteaux de soutien robustes de 14 x 14 cm



MARIPOSA

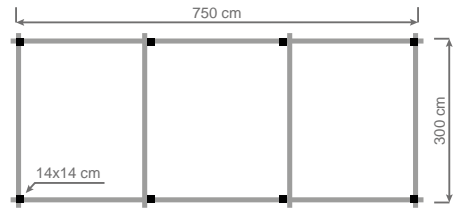

CACERAS

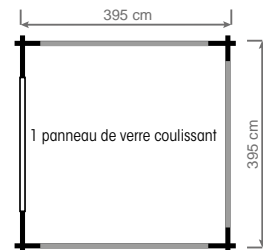



AMOR

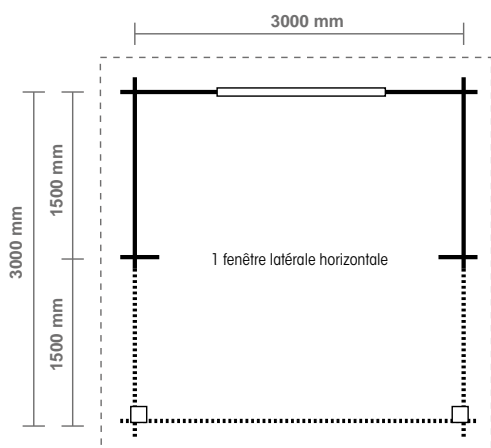

TONNELLES



HATHOR

Set de gouttières et panneaux en option

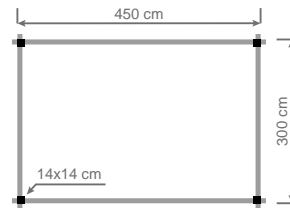

ROMEO

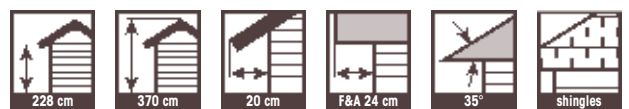
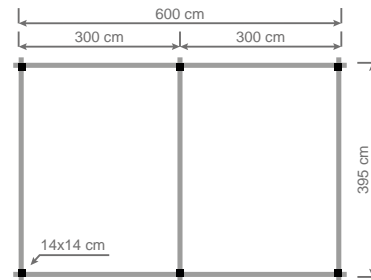

CLEOPATRA

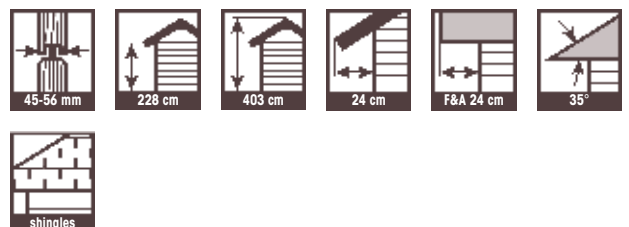
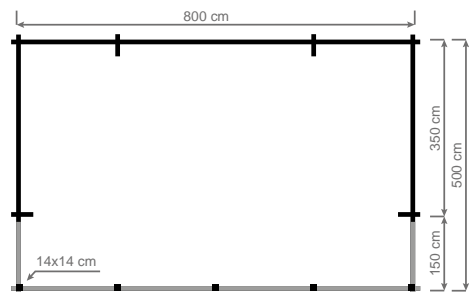



POUR LA GESTION DURABLE DES FORÊTS



CARPORTS



CARPORT EN ANNEXE SUR MESURE



1

- Poteaux de support 14 x 14 cm avec étais (3)
- Toiture en EPDM avec finition en alu
- Gouttières de toit, diamètre 8 cm, système de vidange inclus (1)
- Poutres de toit 58 x 165 mm (2)
- Lattage du toit en bois massif 19 mm (2)
- Fixation à l'aide des supports muraux
- En option : poutres de support 360 cm. Idéal pour des mobil homes ou des camionnettes (4)



2



3



4



OPTIONS ET AVANTAGES



ABRI DE JARDIN ANNEXE

- Hauteur côté extérieur 163 cm, côté annexe 195 cm
- Pente 12°, shingles inclus
- Débord du toit : façade 11 cm, arrière 11 cm, côté 20 cm



PENTE

- Adaptable, 42° maximum
- Pente minimale selon la toiture et le type d'abri de jardin



SOCLE

- Poteaux 14 x 14 cm
- Hauteur 60 cm avec bois de finition
- Planches de 25 mm épaisseur
- Sapin blanc ou chêne



MEZZANINE

- Grenier à dormir confortable
- Avec balustrade
- Le tout selon la construction de base



AUVENT

- Large débord de toit, standard 100 cm
- Plusieurs dimensions possible



APPENTIS INTÉGRÉ

- Joli appentis
- Disponible dans toutes les dimensions possibles
- Avec ou sans plancher de terrasse



BALUSTRADE & TERRASSE

- En poutres traitées autoclaves de 58 x 58 mm
- Planches de terrasse antidérapantes et traitées autoclaves
- Finition avec une balustrade en bois. Epaisseur du bois identique à celle du bois des abris de jardin



ÉTAGE

- Poutres d'étage très résistantes de 58 x 165 mm
- Planches de toit massives de 19 mm



PORTES INTÉRIEURES

- Portes intérieures massives en sapin de Norvège
- Finition élégante

CHEVRONS OUVERTS

- Charpente ouverte très esthétique
- Construction avec poutres de toit de 58 x 165 mm
- Applicable à des constructions de 45 et 56 mm

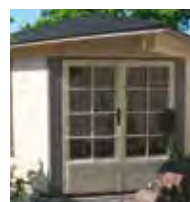

PORTE D'ANGLE

- Porte disposée en biais, dans l'angle
- Porte simple ou double
- Option avec plancher présassemblé de longueur maximale 386 mm
- Idéal pour une construction d'angle, dans le jardin



REHAUSSEMENTS

- Possibilité de rehaussement par tranches de 13 cm
- Pour toutes les épaisseurs de bois
- Applicable à tous nos abris de jardin

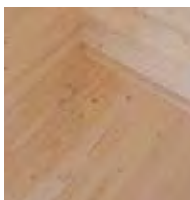

PLANCHER EN BOIS

- Poutres traitées autoclaves de 58 x 58 mm
- Distance entre les poutres de plancher : 40 cm
- Charge illimitée
- Planches de sol massives de 19 mm, avec dent et rainure



TRAITEMENT AUTOCLAVE

- Imprégnation sous vide et sous haute pression
- Protection contre les moisissures et insectes
- Sans parfum ni odeur
- Possibilité de peinture ou teinture après séchage



JEU DE GOUTTIÈRES EN PVC OU GALVANISÉES

- Jeu de gouttières en PVC
- PVC gris de qualité supérieure
 - 80 mm de diamètre
 - Avec tuyaux d'évacuation jusqu'au niveau du terrain

- Jeu de gouttières GALVANISÉES
- Métal galvanisé
 - 125 mm de diamètre pour un grand débit
 - Avec tuyaux d'évacuation jusqu'au niveau du terrain



CHARPENTE

- Poutres de toit robustes de 58 x 165 mm (soudées)
- Classe de résistance C 24
- Planches massives et décoratives de 19 mm (avec dent et rainure)



PIED ADAPTABLE

- Support de poteau réglable,
- Plaque supérieure 80/80,
- Plaque inférieure 160/80, 6 mm d'épaisseur
- Pied en acier galvanisé blanc

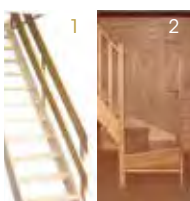

ESCALIERS

1. Escalier Confort
 - Hauteur max. 280 cm, 13 marches
 - Marches: 14 cm de profondeur
 - Largeur: 65 cm
2. Escalier Premium
 - Hauteur max. 280 cm, 13 marches
 - Droit ou quart tournant
 - Largeur: 80 cm
 - Marches: 19 cm de profondeur

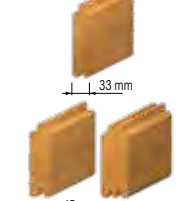

PAROIS

- Parois avec dent et rainure de 15 mm
- Epaisseurs du bois : 33, 45 et 56 mm
- Raccords d'angle droits ou joliment arrondis

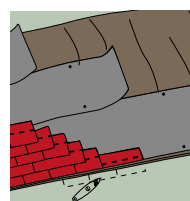

SOUS-TOITURE

- Film synthétique pare-vapeur et très résistant à l'eau
- Epaisseur : 520 microns
- Résistant aux UV
- A appliquer

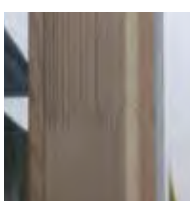

SOUDÉ

- Montant de porte soudé et laminé
- Résiste au gel et à l'humidité
- Le travail naturel du bois est neutralisé



TOIT EN CROUPE

- Triangle pré-monté en planches de 19 mm
- Poutres de support 38 x 89 mm
- Possible sur les toit 2 batières en pente 42°

GRILLE D'AÉRATION

- Double grille, dimensions : 200 x 60 mm, aluminium gris argenté, toile moustiquaire collée dans la grille
- Garantit une aération optimale et une grande longévité





TEINTES ET ENTRETIEN

INFORMATION IMPORTANTE

Nos kits sont livrés non traités, sauf dans le cas de l'autoclave.

Le bois est un matériau naturel, il continue de respirer et de vivre même une fois taillé.

Le bois va donc réagir au climat et impacts extérieurs comme intérieurs du kit. Sa forme et sa taille pourront aussi évoluer dans une certaine mesure au cours du temps. Les fissures de différentes tailles, les changements de structure ou de couleur ne sont pas des défauts, mais plutôt des caractéristiques du bois. Si vous trouvez une poche à sève ouverte pendant la durée de vie de votre kit : ceci est tout à fait normal, votre bois respire. Si vous souhaitez l'enlever, attendez que cette poche soit complètement sèche : pour l'enlever d'un petit coup sec.

Le bois va au contact des U.V., de la pluie, du vent, etc, foncer légèrement à l'intérieur du kit et énormément en extérieur. En l'absence de traitement pour l'extérieur, le bois naturel non imprégné devient grisâtre jusqu'à devenir noir : c'est le champignon "bleu" qui s'installe en surface. L'autoclave retarde le bleuissement mais ne l'empêche pas.

Afin de prolonger la vie de votre kit, ASR vous recommande de protéger vos surfaces extérieures par un insecticide-fongicide puis par un saturateur en solution aqueuse ou une lasure, ainsi que les portes et fenêtres car en cette absence : les portes et les fenêtres peuvent se tordre.

Il n'est pas conseillé de traiter les murs du kit avant de l'assembler. Cependant, si vous souhaitez utiliser différentes couleurs, il peut être judicieux de traiter avant d'assembler certaines pièces comme les couvre-joints.

L'application d'un traitement doit se faire 2 à 3 semaines après le montage par beau temps sec impérativement. Le bois doit avoir un taux d'humidité inférieur à 15 % pour toute application. Vous devez l'appliquer par beau temps bien sec : 96 heures avant l'application, pendant l'application et 48 heures après l'application.

Vous devrez traiter le bois au pinceau large et épais en suivant scrupuleusement les recommandations du fabricant de produit (tant en quantité, qu'en nombre et répétitions dans le temps et les années).

L'insecticide-fongicide **Primer** présenté ci-dessus (**page 132**) est à appliquer : 1 fois dans la vie de votre annexe et en 1 seule couche.

Le **Super Protect** présenté ci-dessus (**page 132**) est à appliquer en 2 couches et à renouveler dès que le gris apparaît.

Le **Viking** présenté ci-dessus (**page 133**) est à appliquer en 2 couches et à renouveler dès que le gris apparaît.

En cas de traitement par **autoclave** présenté ci-après, le fabricant recommande d'attendre 2 à 3 années pour recouvrir votre autoclave par une teinte si vous le souhaitez ou pour renouveler votre traitement par une solution autoclave.

ASR recommande vivement de prendre des produits de grandes marques professionnelles haut de gamme mais n'est en aucun cas responsable du traitement des bois, même si fourni par ASR.

ASR recommande aussi d'inspecter attentivement le kit tous les six mois et de vérifier si le traitement doit être renouvelé.

Dans tous les cas, ASR vous recommande de consulter un spécialiste au sujet des traitements adaptés aux résineux.

Il vous faut suivre dans tous les cas : les instructions du fabricant des produits utilisés.

ASR ne présente aucune garantie sur tous les traitements utilisés, même si fournis par ASR : sous la stricte et seule responsabilité du Client.

OPTION

TEINTES & ENTRETIEN

Toutes les annexes sont livrées à la couleur d'origine (non colorées et non traitées), sauf celles livrées avec l'option : autoclave.

TRAITEMENT PAR AUTOCLAVE VERT DÉJÀ APPLIQUÉ INSECTICIDE - FONGICIDE



SANS AUTOCLAVE

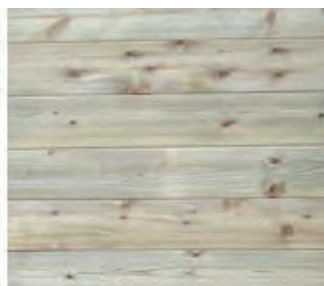
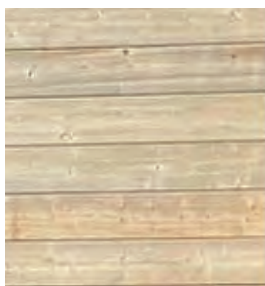

AVEC AUTOCLAVEC THANALITH 4375

Produit : **THANALITH E3475**

DÉCONSEILLÉ POUR L'HABITAT

- Traitement autoclave (sous haute pression)
- Protection contre les moisissures et insectes (inclus contre termites)
- Bois plus résistant aux UV
- Augmentation importante de la durée de vie du bois
- Sans parfum ni odeur
- Couleur vert
- Certifié ATG 91/S143, agrément valable jusqu'au 07/10/2028.



Déroulement du procédé de traitement autoclave sous pression :

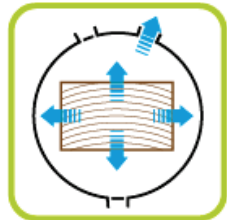

1 - Installation de la palette complète de votre kit dans le tunnel appelé autoclave puis extraction sous vide de l'air s'y trouvant.

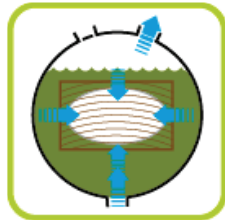

2 - Remplissage sous vide du tube avec la solution : THANALITH E3475

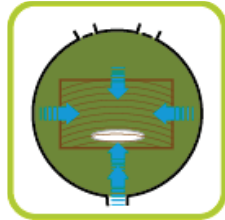

3- Mise sous pression hydraulique de 10 bars.

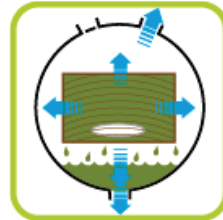

4 - Extraction du produit en excès avec aussi mise en bascule de la palette.

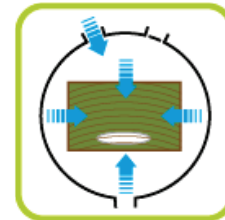

5- Pour favoriser la vidange complète de l'excédent de THANALITH E3475, un retour à la pression normale ambiante est effectué.



6 - Livraison de la palette sous filet pour permettre une meilleure aération avant le montage du kit



Dans tous les cas, ASR vous recommande de consulter un spécialiste au sujet des traitements adaptés aux résineux. Il vous faut suivre dans tous les cas : les instructions du fabricant des produits utilisés. ASR ne présente aucune garantie sur tous les traitements utilisés, même si fournis par ASR : sous la stricte et seule responsabilité du Client.



MaisonBoisChalet.com

N'hésitez pas à nous contacter pour tout renseignement, demande de devis, commande...

Découvrez tous nos autres modèles :

Les **CLASSIQUES** : Abris, Annexes de jardin, Garages, Tonnelles, Chalets... dans notre catalogue : **BIANCASA**.

Notre **BOX** pour les motos, vélos, tondeuses ou autres rangements **dans une surface < à 5 m², démontable et transportable**. Très pratique quand on est locataire : on l'emporte à chaque déménagement.

Les Carports, Abris, Auvents, Tonnelles, Pergolas... dans notre catalogue : **CARPORTS AUVENTS PERGOLAS...**

Les Kotas, Chalets, Pods, Tunnels, Barrels, Tonneaux, Douche et Toilettes extérieures dans notre catalogue **HÉBERGEMENTS INSOLITES**.

Les Kotas, Chalets, Pavillons : Barbecue-Gril, Douche et Toilettes extérieures... dans notre catalogue **BARBECUES GRILS INSOLITES**.

Et tous nos **MEUBLES** en Cèdre blanc massif, dans notre catalogue **MOBILIER**.

Rencontrez-nous à notre exposition et assurez-vous de notre présence en nous appelant avant de venir au :

06.08.30.91.59

En cas de répondeur, laissez-nous un message, s'il vous plaît.

Email : maisonboischalet@aol.fr

Nous vous accueillons avec plaisir dans notre showroom : du mercredi au vendredi de 15h à 19h, le samedi de 15h à 18h. (Veille de fête ou de congés : fermeture à 18h. Jours fériés et congés : fermé) ou sur rendez-vous.



135 route de Bernazobre, à l'angle de la Nationale 126 - 81580 Cambounet-Sur-Le-Sor

